



**choice** 

choice-housing.org

# Repairs Handbook

Working  
together for  
positive change

We put our customers at  
the heart of everything we do.

## About this book

How to contact us	3
Reporting repairs	5
Our service	7
What you must do	9
Response times	11
Our standards	13
Improvements	15

Baths, basins	17
Communal areas	19
Doors, locks	21
Drains, wastes	23
Electrics	25
Floors, stairs	27
Garden area	29
Gutters	31
Heating	33
Kitchen fittings	35
Pipes, taps	37
Roofs	39
Toilets	41
Walls, ceilings	43
Windows	45

Handy hints	47 - 60
-------------	---------

# About this book

This book provides you with information about the repairs service provided to you by Choice Housing Ireland Ltd. It also tells you what we need to know in order to arrange a repair to your home, what repairs you are expected to do and how to do some of these yourself.

## Before you contact us about a repair

- Please look at the appropriate section on pages 17 to 46 to see what details we need to know about your repair problem. By giving us as much information as you can, you will help us get your repair problem fixed quickly.
- Decide when someone can be at home to allow the repair worker in to do the work. A responsible adult must be in the home while the repair is being done.
- Have a pen and paper ready to write down any information we give you.

## When you are ready to contact the Choice Services Centre

- Find out how to contact us on page 3.
- Let us know your name, address and a contact phone number.
- Let us know about any special circumstances we need to take into account, for example if you are hard of hearing or have difficulties getting to the door when someone comes to your home.
- Please have this book with you to help you talk through your repair with us.

Please tell us if you would like any part of this book explained or produced on tape, on CD, or in Braille **or large print.**

This book was developed by staff and tenants working together.

## Emergencies - what to do

### ■ Gas (smell, leak or fumes)

- Call the Northern Ireland Gas Emergency Number immediately on **0800 002001**. Use a phone outside your home; using one inside, even a mobile, could spark an explosion.
- Turn off the gas and open windows. Turn the handle at the meter to the flat (horizontal) position.
- Do not smoke or switch anything electrical on or off until the problem is fixed.



### ■ Smoke or fumes or your smoke detector alarm sounds

- If you can smell or see smoke call **999** or **112** immediately.
- If there is no sign of smoke or fire check whether the alarm has been set off by something else. See **Handy hints** on page 57.

■ **Electricity.** Turn the mains switch on the consumer unit to OFF. If you have a power cut, call **N.I.E.** on **0845 7643 643**.

■ **Water.** Turn the main stoptap to the right (clockwise ↻). If you have no water supply, call the Water Service on **0845 744 0088**.

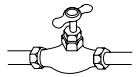

## Where is it in your home?

■ Gas meter

■ Consumer unit (fusebox)

■ Mains water stoptap

About this book 1

## How to contact us

Reporting repairs 5

Our service 7

What you must do 9

Response times 11

Our standards 13

Improvements 15

Baths, basins 17

Communal areas 19

Doors, locks 21

Drains, wastes 23

Electrics 25

Floors, stairs 27

Garden area 29

Gutters 31

Heating 33

Kitchen fittings 35

Pipes, taps 37

Roofs 39

Toilets 41

Walls, ceilings 43

Windows 45

Handy hints 47 - 60

# How to contact us

Your phone calls to us may be recorded for training or quality control purposes.

- **Phone the Choice Services Centre**.....0300 111 2211
  - Our office hours are 9am - 5pm, Monday to Friday.
  - At weekends, on public holidays and after 5pm on weekdays, we will only respond for emergency repairs.
  - If you have a textphone, please dial 18001 before the telephone number you want to call.
- **E-mail us or text us**.....repairs@choice-housing.org  
(please do not use e-mail or text for emergency or urgent repairs) 07880 678123
- **Complete a form on our website** .....www.choice-housing.org
- **Visit our head offices**..... **Leslie Morrell House**, 37-41 May Street, Belfast, BT1 4DN  
**Maple House**, Beechill Business Park, 96 Beechill Road, Belfast, BT8 7QN
- **Write to us**.....Maintenance Request, Choice Services Centre, Leslie Morrell House, 37-41 May Street, Belfast, BT1 4DN

We expect our staff and contractors to be considerate and respectful towards you. We expect you, your family and visitors to behave in a similar way towards them.

## When you contact us

- If our customer advisors are very busy and you are waiting in a queue, we will answer your call as soon as we can, but you could try again later.
- If you are calling about a repair you have already reported, please tell us the job reference number we gave you when you first contacted us.

### **Warning - check identity cards!**

Anyone who comes to your home to carry out a repair, inspection or gas service will have an identity card with their photo on it. You should check the card carefully. Also, check that they are coming to do a repair or servicing you are expecting and that the number on their works order is the same as the job reference number we gave you when you reported your repair. This also appears in your repair acknowledgement letter.

If you are at all unsure, ask them to stay outside and phone the Choice Services Centre.

## Home contents insurance

Choice Housing does not insure tenants' furnishings or belongings. We strongly advise you to take out your own home contents insurance. This will cover you against damage to your personal belongings, floor coverings, furniture and other contents and decorations, including damage from a fire, flood, break-in, vandalism or accident. It would also cover certain items stolen in a break-in.

When choosing an insurance scheme, make sure it will cover broken glass and locks in doors and windows.

# Reporting repairs

About this book	1
How to contact us	3

## Reporting repairs

Our service	7
What you must do	9
Response times	11
Our standards	13
Improvements	15

Baths, basins	17
Communal areas	19
Doors, locks	21
Drains, wastes	23
Electrics	25
Floors, stairs	27
Garden area	29
Gutters	31
Heating	33
Kitchen fittings	35
Pipes, taps	37
Roofs	39
Toilets	41
Walls, ceilings	43
Windows	45

Handy hints	47 - 60
-------------	---------

### Before you call

- Look up the problem on one of the sections on pages 17 to 46.



### When you call, let us know:

- your name, address, postcode, and a contact phone number;
- details of the item that needs repairing; and
- when a repair worker can come to do the work.



### We will assess the repair

- We will tell you if it is your responsibility to arrange the repair.
- If it is our responsibility, we will place an order with a local contractor, **or** a Maintenance Officer will contact you to discuss what needs to be done.

### We will confirm the repair

We will give you:

- a target date by which the repair should be finished;
- the name of the contractor who will do the work; and
- the job reference number. This will also appear on the repair worker's works order.



### Our contractor will contact you

Our repairs contractor will phone you to agree when they will come to carry out the repair. If it is an emergency they will tell you how soon they will be at your home. For all other repairs they will try to agree a morning or afternoon on a specific date (Monday to Friday only). **Please make sure we have your correct phone number.**

## When you report a repair

- We may need to phone you or visit your home before ordering any repairs so we can assess exactly what work needs to be done.
- We will make a charge if you knowingly exaggerate the urgency of the problem to get a quicker (emergency) response.
- At weekends, on public holidays and after 5pm on weekdays we will only send out a repair worker if it is an emergency.

## When work is going to be done in your home

- The contractor will tell you if you need to move or protect any furniture, or if you need to lift any floor covering (carpets, laminate). You should do this before the repair worker arrives, but let us know if you are having difficulties arranging this.
- Repair workers need you, or another responsible adult, to be in the home while they work. They may need to discuss with you any problems that arise. We insist that repair workers must not work in homes where the only person(s) at home are under 16 years old.
- You need to make sure that the repair workers can get on with their work safely. You must keep any pets out of the way, and keep your children under control. Repair workers can refuse to work if they feel that their health or safety, or yours, is at risk.
- In very bad weather we will always make things safe but repair workers may not be able to carry out a full repair. This is for their own safety.

About this book	1
How to contact us	3
Reporting repairs	5

## Our service

What you must do	9
Response times	11
Our standards	13
Improvements	15

Baths, basins	17
Communal areas	19
Doors, locks	21
Drains, wastes	23
Electrics	25
Floors, stairs	27
Garden area	29
Gutters	31
Heating	33
Kitchen fittings	35
Pipes, taps	37
Roofs	39
Toilets	41
Walls, ceilings	43
Windows	45

Handy hints	47 - 60
-------------	---------

# Our service

## Our responsibilities

### Your home.

We repair and maintain the structure and outside parts of the property you live in, such as gutters and roof tiles.

Inside your home, we are responsible for water and gas pipes, wiring, heating systems, drainage, power and light fittings, and any items originally provided with your tenancy, but not items that are listed as your responsibility. See **What you must do** on page 9.

### Your garden.

In the private part of your garden we are responsible for fences, walls and gates which are provided as part of the tenancy or changed by you with our permission. We are also responsible for the main paths that lead to your front and back doors.

### Shared (communal) areas.

We maintain any open area around your home and any shared or communal areas and facilities that we own.

## Responsibility for gas safety

- We are responsible for carrying out a gas safety check once a year in every property we own that has a gas supply (even if you don't use it).
- You must allow us into your home to carry out these checks. This is for your safety. If you do not allow us in we may have to force entry or take court action to gain access.
- You must make sure that air vents do not become blocked.



## What repairs and maintenance do Choice Housing carry out?

We will carry out repairs to the outside of your property, the main structure of the building, and any fittings and appliances provided with your tenancy. We will also maintain shared or communal areas of our buildings. See **Our responsibilities** on page 7.



We must, by law, carry out an annual service of any gas appliance that we are responsible for. Also, we must carry out a safety check on all gas pipework even if it leads to your own appliance. This is done for us by specialist gas contractors. It is your responsibility to make sure that your own gas appliances are serviced annually.

## What if I can't carry out my responsibilities?

You are responsible for taking care of the inside of your home and for certain repairs. See **Tasks you must do** on page 10. However, if you are vulnerable, infirm or disabled and have no-one who can help you, we may be able to help you or put you in touch with other organisations.

## Do I have to pay for any repairs?

If damage was caused by you or someone in your home or Police forced entry, we expect you to arrange to get it repaired. If we have to do the repair to make sure you and your family are safe you will have to pay for the cost of the repair. See **Damage and charging** on page 9.

## Can I claim for damage to my belongings?

If damage was caused by repair workers doing work for us you need to write explaining the problem to 'The Property Services Manager' at our head office. See **How to contact us** on page 3 for the address. For any other damage, for example accidents, you should take out home contents insurance. See **Home contents insurance** on page 4.

## Our service

About this book	1
How to contact us	3
Reporting repairs	5
Our service	7

### What you must do

Response times	11
Our standards	13
Improvements	15

Baths, basins	17
Communal areas	19
Doors, locks	21
Drains, wastes	23
Electrics	25
Floors, stairs	27
Garden area	29
Gutters	31
Heating	33
Kitchen fittings	35
Pipes, taps	37
Roofs	39
Toilets	41
Walls, ceilings	43
Windows	45

Handy hints	47 - 60
-------------	---------

# What you must do

## Your responsibilities are:

- to let us know as soon as you notice a repair is needed and to take action to prevent it getting worse;
- to allow repair workers into your home to carry out repairs, safety checks and inspections;
- to decorate the inside of your home to a reasonable standard, including filling minor cracks or holes in walls;
- to repair and maintain your own appliances and any changes you have made to your home. See **Improvements** on page 15;
- to take action to prevent and control the build up of condensation and to prevent pipes from freezing or bursting;
- to prevent blockages in wastepipes or drains; and
- to make sure that, when you decide to move, your home is in a good enough condition for us to let it again quickly.

## Damage and charging

If you, or anyone in your home, cause damage to your home, we expect you to arrange to get it repaired. If we have to do the repair to make sure you and your family are safe you will have to pay for the cost of the repair. This will include an administration charge.

If damage is caused by vandalism or break-in, you will also have to arrange the repair. You may be able to make a claim on your home contents insurance to cover the cost of the repair. See **Home contents insurance** on page 4.

If damage is caused by civil unrest, we will carry out work to make your home safe. We will only do further work if you supply us with a police crime report number (not an incident number given over the phone).

## Tasks you must do

You are expected to do these yourself, or arrange and pay to get them done (Scheme Co-ordinators or support staff may help with some of these):

- replacing locks or keys when keys are lost or you get locked out;
- getting extra keys cut or fitting extra locks;
- replacing glass in windows or doors (see **Damage** on page 9);
- draught-proofing doors or windows;
- fitting and replacing door bells, latches, handles and chains;
- oiling locks and hinges and adjusting doors, particularly when you have new floor coverings fitted;
- fitting and replacing curtain rails, pelmets, picture rails and hooks;
- replacing light bulbs, pullcords, fluorescent tubes and starters;
- resetting trip switches or fuses;
- testing smoke detectors (see **Handy hints** on page 57);
- fitting and replacing TV aerials and sockets (unless communal aerials);
- bleeding radiators if necessary;
- cleaning through drains and wastepipes regularly;
- trying to clear blocked basins, sinks, baths and toilets;
- replacing toilet seats;
- replacing plugs and chains on baths, basins and sinks;
- replacing shower heads, hoses and curtains, and descaling shower heads regularly;
- fitting bathroom cabinets, toilet roll holders and mirrors;
- fitting washing machines and dishwashers and vents for tumble driers;
- replacing washing lines, unless in a communal area;
- maintaining general garden paths (not those to front or back doors);
- keeping gully grids clear;
- repairing sheds or outbuildings; and
- replacing fire surround tiles.

# Response times

When you report a repair to us we will discuss the nature of the problem. We will then tell you what response time category we have placed it in. The response times are measured from the date you report the problem to us.

- **Emergency. We aim to respond within 24 hours.** For repairs that remove immediate danger to people, avoid flooding or major damage to the property, make the property secure, or restore total loss of heating in winter. Work will be done to make the situation safe. We will let you know when we will do the follow up work. **You can call us about emergencies at any time of day or night but if we find you have knowingly exaggerated the situation we will charge you.**

**Assessments.** We may need to discuss your repair in more detail. Your Maintenance Officer may contact you within 3 days or 20 days depending on the type of repair.

- **Urgent. We will complete the repair within 4 working days depending on the type of problem.** For work to restore full or partial failure of sanitation, water or electrical supply, or heating systems, and any other urgent work to prevent immediate damage to the property, to overcome serious inconvenience to the tenant or where there is a possible health, safety or security risk.
- **Normal. We will complete within 20 working days.** For work where the fault or failure does not cause immediate inconvenience or present a danger to occupants or the public, but should not wait for a planned programme of work.

About this book	1
How to contact us	3
Reporting repairs	5
Our service	7
What you must do	9

## Response times

Our standards	13
Improvements	15

Baths, basins	17
Communal areas	19
Doors, locks	21
Drains, wastes	23
Electrics	25
Floors, stairs	27
Garden area	29
Gutters	31
Heating	33
Kitchen fittings	35
Pipes, taps	37
Roofs	39
Toilets	41
Walls, ceilings	43
Windows	45

Handy hints	47 - 60
-------------	---------

## How long will it take?

When you report a repair, a customer advisor will assess the problem and put it into a response time category. See **Emergency**, **Urgent**, and **Normal** on page 11. In some cases, we may need to call you or visit your home to assess exactly what work needs to be done. For emergency repairs, a repair worker will call at your home as soon as possible, but always within 24 hours. For urgent and normal repairs the contractor should contact you to agree when the work will be done.



## What if the work is not done on time?

If a repair worker does not come within the response time or keep to a specific morning or afternoon agreed with you, please contact the Choice Services Centre and we will follow it up immediately. Under the Right to Repair regulations, you have a right to have certain repairs done within set time limits. We can send you a leaflet about this.

## What if I can only be in at certain times?

If you cannot be in during our normal working hours you could arrange for someone to stay in your home while the contractor does the work. This should not be anyone under 16 years old. If the repair is to the outside of your home, you may not have to be in, but make sure the repair workers can get access to the area. If you cannot keep to an appointment with a contractor, please contact the Choice Services Centre immediately. If no one is at home when the repair worker comes, he or she will leave a card asking you to phone to agree when they will come again. If you are not in the second time the contractor will tell us and we will cancel the repair and may charge you for the contractor's wasted time.



## Response times

# Our service standards

About this book	1
How to contact us	3
Reporting repairs	5
Our service	7
What you must do	9
Response times	11

## Our standards

Improvements	15
--------------	----

Baths, basins	17
Communal areas	19
Doors, locks	21
Drains, wastes	23
Electrics	25
Floors, stairs	27
Garden area	29
Gutters	31
Heating	33
Kitchen fittings	35
Pipes, taps	37
Roofs	39
Toilets	41
Walls, ceilings	43
Windows	45

Handy hints	47 - 60
-------------	---------

## Our code of behaviour

Our Customer Advisors and

Maintenance Officers will:

- answer calls promptly;
- be polite, honest and helpful; and
- make a record of what is discussed.

Anyone working in your home will:

- treat you with respect and always behave in a professional way;
- introduce themselves and show you photo identification before entering;
- explain what they are going to do and discuss how this will affect you;
- be appropriately dressed;
- make sure materials and tools do not cause danger to anyone;
- keep you informed about how the work is progressing;
- make sure electricity, water and gas are connected at the end of the day;
- protect your belongings from damage, dust and paint; and
- clear rubbish from your home and garden at the end of each day.

## Repair workers are not allowed to:

- smoke, play radios or use bad language in or around the home;
- use mobile phones to make or receive private phone calls during their work time;
- be in your home with children under 16 without a responsible adult being present;
- receive money, services or gifts from tenants; or
- keep keys to tenants homes.

Also, they must ask your permission to:

- use your phone;
- use your toilet;
- go into other rooms in your home; or
- take their lunch break in your home.

**What standard of service can I expect?**

We will respond to repair problems in an efficient and helpful way. Most repairs are carried out by appointed contractors. We will tell you the name of the contractor who will be given your repair order. We select these contractors carefully on the basis of their standard of work and value for money. Some minor repairs may be carried out by Choice's team of Maintenance Assistants.

Anyone working in or around your home must follow certain rules of behaviour. See **Our code of behaviour** on page 13.



**Do you check up on the quality of service or workmanship?**

We carry out regular checks to make sure that we provide a good standard of service. This is done by selecting a number of completed repairs on a random basis, and contacting you by phone or post to find out what you think. Sometimes your maintenance officer will make an appointment to visit your home to check a recent repair.

**What if I am not satisfied with the quality of work or want to make a suggestion?**

Please contact Choice Services Centre if your repair was not completed within the time allowed or if you are not satisfied with the work that has been done or the way you have been treated. We will try and get the matter sorted out as soon as possible. If you want to take the matter further, you need to follow certain recommended steps. Ask one of our customer advisors to send you a leaflet which explains how to make a complaint. We want to keep improving the service we provide, so we welcome your comments, suggestions or complaints. We also carry out surveys from time to time to ask for your views about our services.

**Our service standards**

# Improvements and adaptations

About this book	1
How to contact us	3
Reporting repairs	5
Our service	7
What you must do	9
Response times	11
Our standards	13

## Improvements

Baths, basins	17
Communal areas	19
Doors, locks	21
Drains, wastes	23
Electrics	25
Floors, stairs	27
Garden area	29
Gutters	31
Heating	33
Kitchen fittings	35
Pipes, taps	37
Roofs	39
Toilets	41
Walls, ceilings	43
Windows	45

Handy hints 47 - 60

## Changes you can make

You may carry out changes to your home but you must discuss your plans with us first. This includes laying floor tiles, or wood or laminate flooring.

You should then write to us, giving full details of what you plan to do.

We will write back to you with an answer within one month.

We have the right to insist that work is done in a certain way, and to inspect it at certain stages.

Once you have done the changes we have agreed to, we will be responsible for any repairs.

## Planning permission

You should check whether you also need to get official planning permission and building regulations approval. You are responsible for applying for these.

## Compensation for improvements

At the end of your tenancy, you may get compensation for certain improvements you have done. We can give you a list of what kinds of improvements these are.

The amount will be based on the original cost of the improvement and how long it has been in use.

We will not pay compensation if:

- you did not get our written permission to do the work; or
- we have had to evict you because you broke the tenancy conditions.



## Can I carry out improvements myself?

You can carry out alterations, changes or improvements to your home as long as you have our written permission. This covers any changes you want to make to the inside of your home, decorating the outside or putting up any structures outside. You need to give us full details of the work and who will carry it out. You may also need official planning permission and have to follow relevant building regulations. See **Changes you can make** on page 15. If you remove fixtures or fittings or carry out alterations without permission, we may ask you to put back or restore them to the original condition. If we have to do this, we will charge you for the costs involved.

## Will I be compensated for improvements that I make?

You may get compensation for certain types of improvement. We will agree it and pay it only when you end your tenancy. We can give you a list of improvements that qualify for compensation. See **Compensation for improvements** on page 15.



## What help is there if I am disabled?

We may be able to carry out certain adaptations to help you in your home (for example, handrails or bathroom adaptations). Contact us about your particular needs.

## Do you plan to improve my home or area?

We put together a programme of major repairs and improvements to our properties and surrounding areas once a year. We will put the most urgent problems first and the amount we do will depend on what money we have available. We will consult you, well ahead of time, about any work we expect to do in your home (for example, double-glazing or a new heating system).

## Improvements and adaptations

About this book	1
How to contact us	3
Reporting repairs	5
Our service	7
What you must do	9
Response times	11
Our standards	13
Improvements	15

## Baths, basins

Communal areas	19
Doors, locks	21
Drains, wastes	23
Electrics	25
Floors, stairs	27
Garden area	29
Gutters	31
Heating	33
Kitchen fittings	35
Pipes, taps	37
Roofs	39
Toilets	41
Walls, ceilings	43
Windows	45

Handy hints 47 - 60

# Baths, basins and sinks

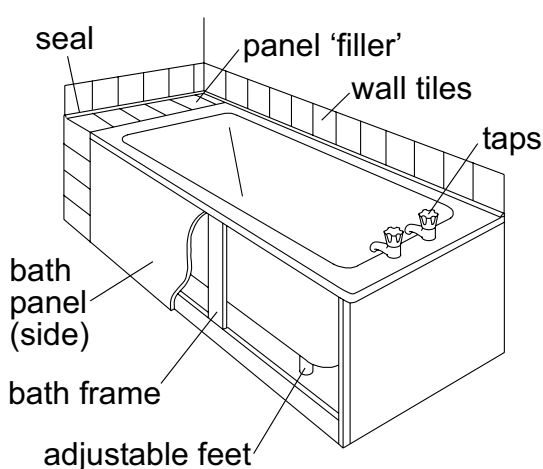

**bath**

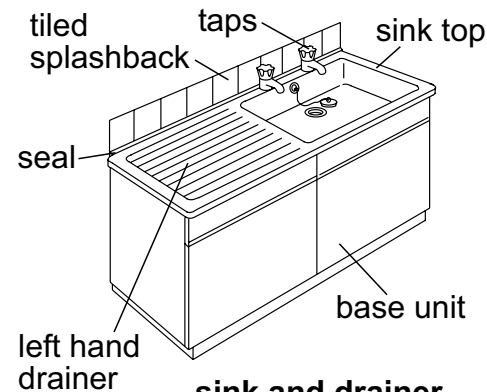

**sink and drainer**

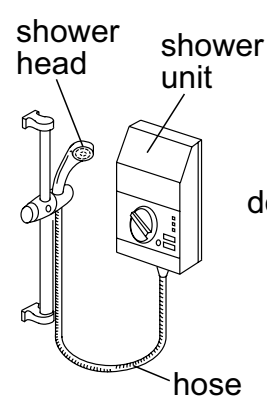

**electric shower**

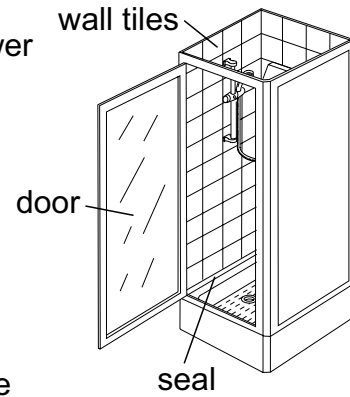

**shower cubicle**

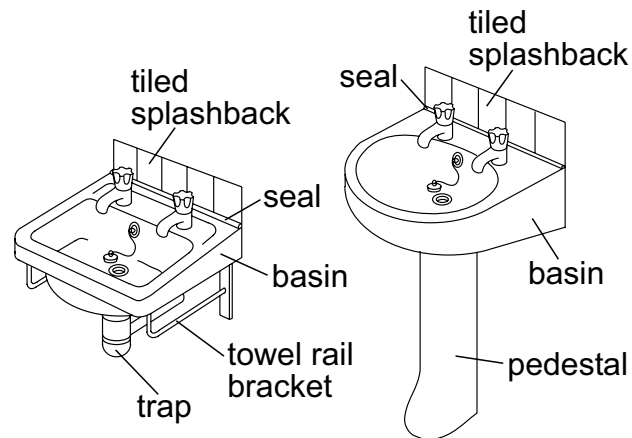

**wash hand basins**

## Your responsibilities

- Cleaning through all wastepipes and drains regularly to prevent blockages.
- Trying to clear blocked baths, basins, sinks. See **Handy hints** on page 47.
- Replacing plugs and chains to baths, basins and sinks.
- Fitting bathroom cabinets, mirrors, etc.
- Descaling showerheads and replacing broken showerheads.
- Repairing any items you have installed yourself, eg shower, extra tiles.

## Advice

- For water leaks or tap problems, see **Pipes and taps** on page 37.
- A blocked waste is **not** an emergency. You must try to clear any blockages yourself before you call us. See **Handy hints** on page 47.
- We will charge you for clearing blockages caused by items such as toys, hair, cooking oil, tea leaves and food waste.
- If you, a member of your family or a visitor cause damage and we have to repair it, you will have to pay the cost of the repair.

## We need to know

- **What is the problem, eg:** bathroom fittings loose or broken; wastepipe leaking or blocked; splashback wall tiles cracked or broken?
- **If a panel**, is it the side or the end? Is it made of plastic or hardboard?
- **If a bath or basin**, what is it made of: plastic, ceramic or metal (cast iron)? What colour is it?
- **If tiles**, what shape, size and colour are they?
- **If a shower**, what type is it: dished floor, step-in tray, or level access?

## Baths, basins and sinks

About this book	1
How to contact us	3
Reporting repairs	5
Our service	7
What you must do	9
Response times	11
Our standards	13
Improvements	15

Baths, basins	17
---------------	----

## Communal areas

Doors, locks	21
Drains, wastes	23
Electrics	25
Floors, stairs	27
Garden area	29
Gutters	31
Heating	33
Kitchen fittings	35
Pipes, taps	37
Roofs	39
Toilets	41
Walls, ceilings	43
Windows	45

Handy hints	47 - 60
-------------	---------

# Communal areas

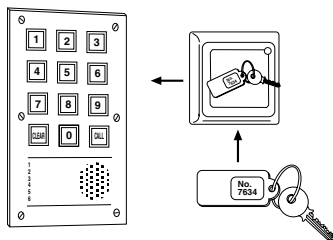

door entry system

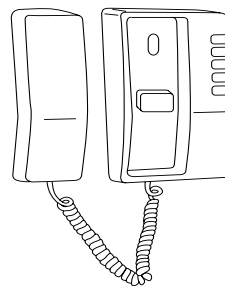

entry phone in your flat  
(with handset)

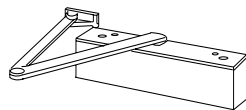

overhead door closer

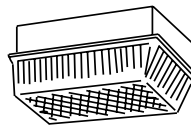

bulkhead light

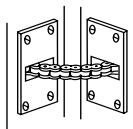

single chain

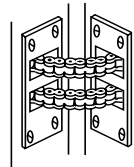

double chain

perko door closers

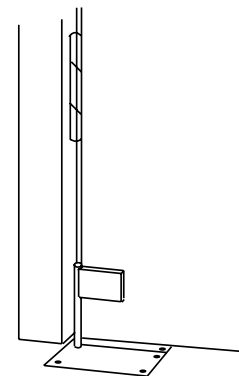

floor spring door closer

## Your responsibilities

- Replacing keys or fobs to common entrance doors when they are lost. See **Advice** below.
- Keeping all common staircases, corridors, hallways, landings and external areas tidy, safe and free of obstructions.
- Reporting repairs to us quickly.

## Advice

- Any repair problems in common areas should be reported directly to Choice Services Centre.
- If you need additional or replacement keys or fobs to common entrance doors, you should contact us. We can provide these but we will charge you for them.

## We need to know

- **What is the problem, eg:** door entry phone not working; door closer loose or broken; lock broken, missing or jammed; lights not coming on; stair nosing coming off; laundry equipment faulty; lift broken?
- **If an entry phone**, is the problem in your flat or at the main entrance? Is the door closing properly? Is it a key or fob system?
- **If lights**, is it a wall or ceiling light?
- **If a bulkhead light**, where is it and how high is it?
- **If stair nosing in communal area:** is it metal strip, plastic strip, concrete, tiled or non-slip surface?
- **If graffiti**, where is it and what does it say?



## Communal areas

# Doors and locks

About this book	1
How to contact us	3
Reporting repairs	5
Our service	7
What you must do	9
Response times	11
Our standards	13
Improvements	15

Baths, basins	17
Communal areas	19

## Doors, locks

Drains, wastes	23
Electrics	25
Floors, stairs	27
Garden area	29
Gutters	31
Heating	33
Kitchen fittings	35
Pipes, taps	37
Roofs	39
Toilets	41
Walls, ceilings	43
Windows	45

Handy hints	47 - 60
-------------	---------

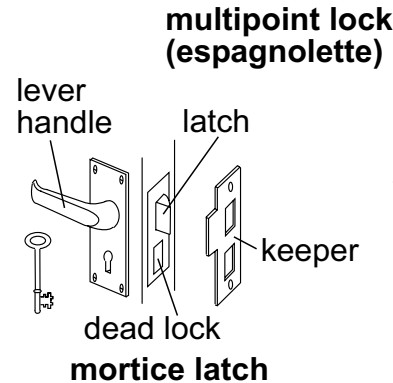
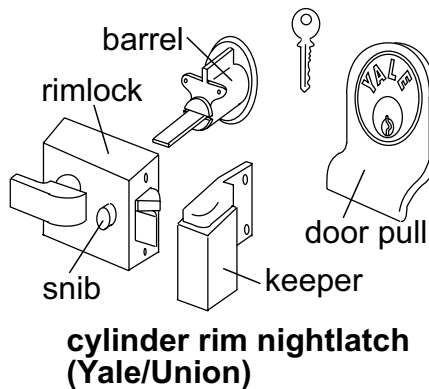
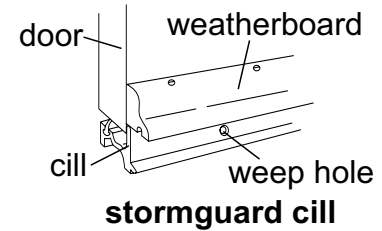
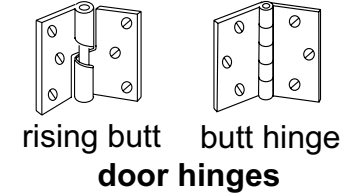
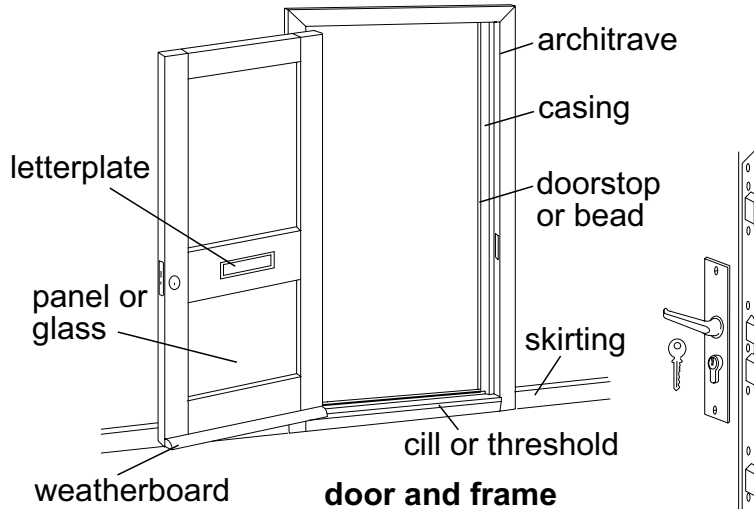

**multipoint lock (espagnolette)**

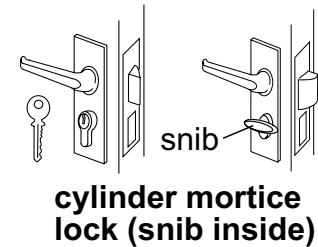
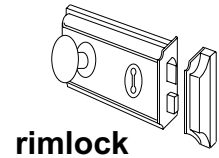

## Your responsibilities

- Replacing keys or locks when keys are lost or broken, or you get locked out. (If it is a suite key, we will provide you with a new key and make a charge.)
- Getting extra keys cut and fitting any additional locks.
- Fitting bells, knobs, handles, latches or chains.
- Replacing broken glass, unless you give us a police crime report number.
- Oiling locks and hinges and adjusting doors, particularly when you have fitted new carpets or laminate flooring.

## Advice

- If you, a member of your family or a visitor cause damage and we have to repair it, you will have to pay the cost of the repair.
- We will only do emergency repairs to make the property safe and secure. If necessary, the full repair will be done at a later date.
- If a problem is caused by civil unrest, you should report it to the Police and get a crime report number (not an incident number given over the phone), otherwise we may charge you for the cost of the repair.

## We need to know

- **What is the problem, eg:** lock stiff or not fitting properly into the keep; lock or handle broken; door sticking, not closing properly or damaged?
- **Which door is it:** front, back or side? Is it a sliding door? Is it communal? What type of lock or latch has it got? **Is the property still secure?**
- **What is it made of:** wood, plastic (pvcu) or metal?
- **What type of lock is it:** mortice, cylinder mortice, cylinder rim nightlatch (Yale or Union), rimlock or multipoint?



## Doors, locks

# Drains and wastes

About this book	1
How to contact us	3
Reporting repairs	5
Our service	7
What you must do	9
Response times	11
Our standards	13
Improvements	15

Baths, basins	17
Communal areas	19
Doors, locks	21

## Drains, wastes

Electrics	25
Floors, stairs	27
Garden area	29
Gutters	31
Heating	33
Kitchen fittings	35
Pipes, taps	37
Roofs	39
Toilets	41
Walls, ceilings	43
Windows	45

Handy hints	47 - 60
-------------	---------

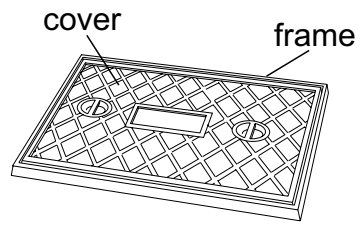

**inspection chamber**

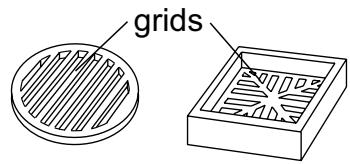

**gully grids**

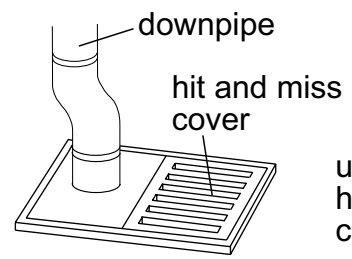

**back inlet gully**



**bottle trap**

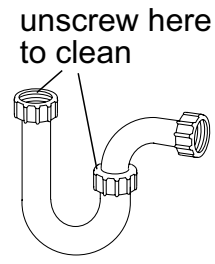

**'P' trap**

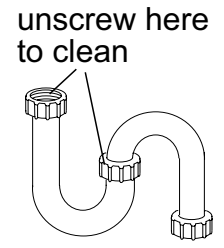

**'S' trap**

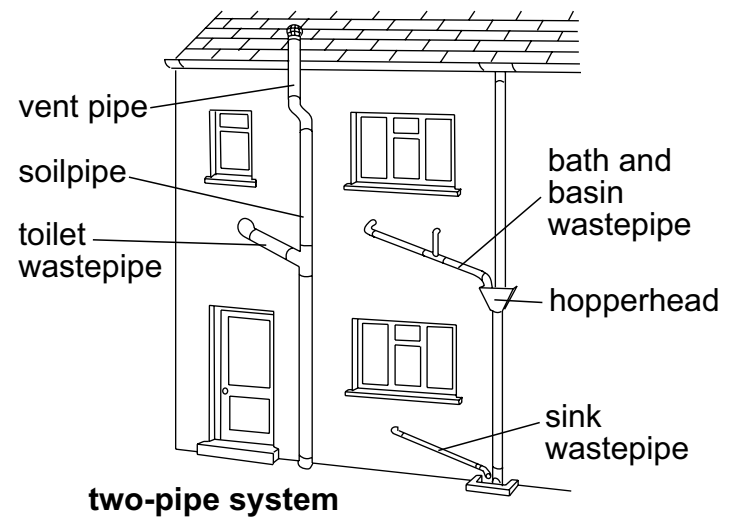



## Your responsibilities

- Clearing through all wastepipes and drains regularly to prevent blockages.
- Trying to clear blocked baths, basins, sinks or toilets.
- Clearing blockages or repairing leaks from washing machines or dishwashers.
- Keeping gully grids clear of leaves and rubbish.

## Advice

- A blocked waste is not an emergency. You are expected to try to clear it yourself. See **Handy hints** on page 47. A blocked toilet is not an emergency unless you have no other toilet you can use.
- Keep your wastes and drains clear by flushing them regularly with hot water and using cleaning products you can buy in shops. Always follow the instructions carefully.
- If a blockage is caused by items such as cooking oil, food waste, nappies or sanitary products, we will charge you for the cost of clearing it. You should always try to clear it yourself before calling us. See **Handy hints** on page 47.

## We need to know

- **What is the problem, eg:** wastepipe blocked or leaking; drain smelling or blocked; gully blocked or grid missing?
- **If a wastepipe, which is it:** bath, basin, sink, shower or toilet?
- **If a wastepipe is blocked:** is more than one fitting blocked, or if you live in a block of flats, are any other flats affected?
- **If the drain is blocked,** is it overflowing?
- **If a gully grid,** is it round or square? What is it made of: metal or plastic?



## Drains, wastes

About this book	1
How to contact us	3
Reporting repairs	5
Our service	7
What you must do	9
Response times	11
Our standards	13
Improvements	15

Baths, basins	17
Communal areas	19
Doors, locks	21
Drains, wastes	23

**Electrics**

Floors, stairs	27
Garden area	29
Gutters	31
Heating	33
Kitchen fittings	35
Pipes, taps	37
Roofs	39
Toilets	41
Walls, ceilings	43
Windows	45

Handy hints 47 - 60

# Electrics

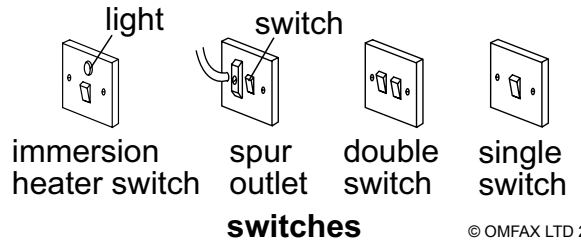
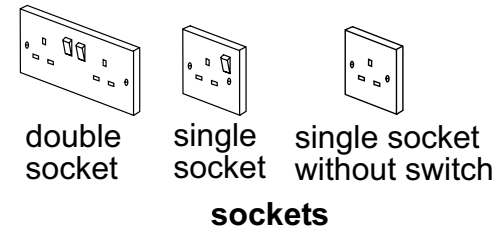
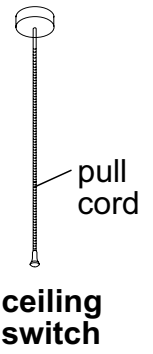
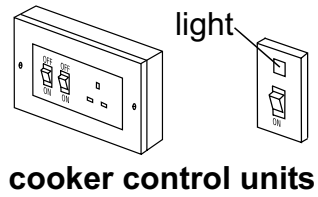
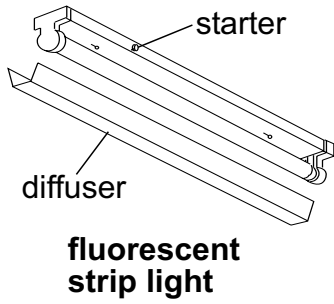
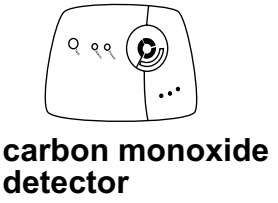
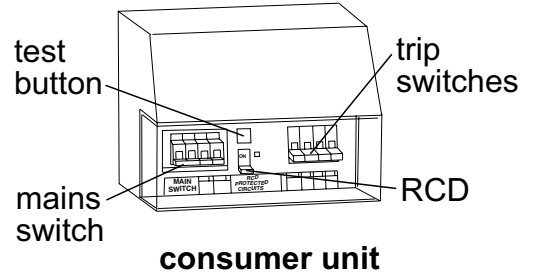
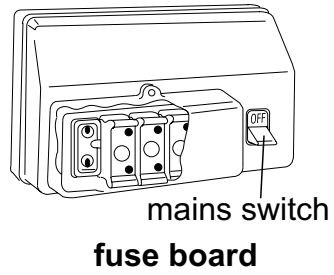

## Your responsibilities

- Resetting trip switches or changing fuses and, if necessary, turning off the mains supply. See **Handy hints** on pages 49 to 52.
- Replacing light bulbs, fluorescent tubes and starters.
- Replacing electrical plugs (not socket outlets) and plug fuses for your own appliances.
- Testing and cleaning your smoke detector if it is battery-operated. See **Handy hints** on page 57.

## Advice

- **Do not touch** bare wires and **do not touch** sockets or switches with wet hands. Also, if water is leaking onto electrical fittings or a fitting is dangerous, **do not use or touch** any switches connected to it. Contact the Choice Services Centre immediately.
- Make sure that you know where the trip switches are located in your home and understand how to reset them. See **Handy hints** on page 49.
- If you caused any damage or you call us out when you have not fed your meter, we will charge you for calling out a repair worker and for the cost of any repair work carried out.

## We need to know

- **What is the problem, eg:** no lights or power in part of, or throughout the property; light or light switch not working; socket loose or broken?
- **What type of fitting or socket is it?**
- **Are other homes in your block or nearby buildings affected?**
- **Are there any other connected problems?**

## Electrics

About this book	1
How to contact us	3
Reporting repairs	5
Our service	7
What you must do	9
Response times	11
Our standards	13
Improvements	15

Baths, basins	17
Communal areas	19
Doors, locks	21
Drains, wastes	23
Electrics	25

<b>Floors, stairs</b>	
Garden area	29
Gutters	31
Heating	33
Kitchen fittings	35
Pipes, taps	37
Roofs	39
Toilets	41
Walls, ceilings	43
Windows	45

Handy hints	47 - 60
-------------	---------

# Floors and stairs

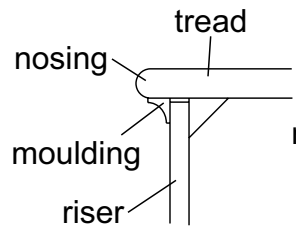

**step details**

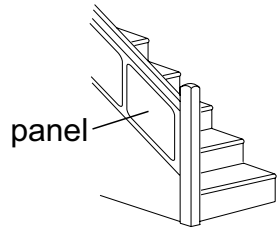
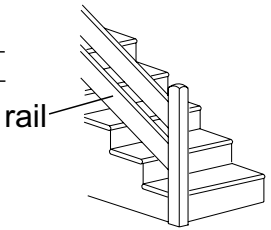

**types of stairs**

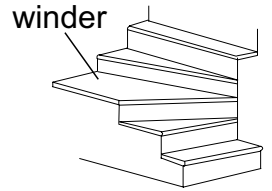

## balustrade

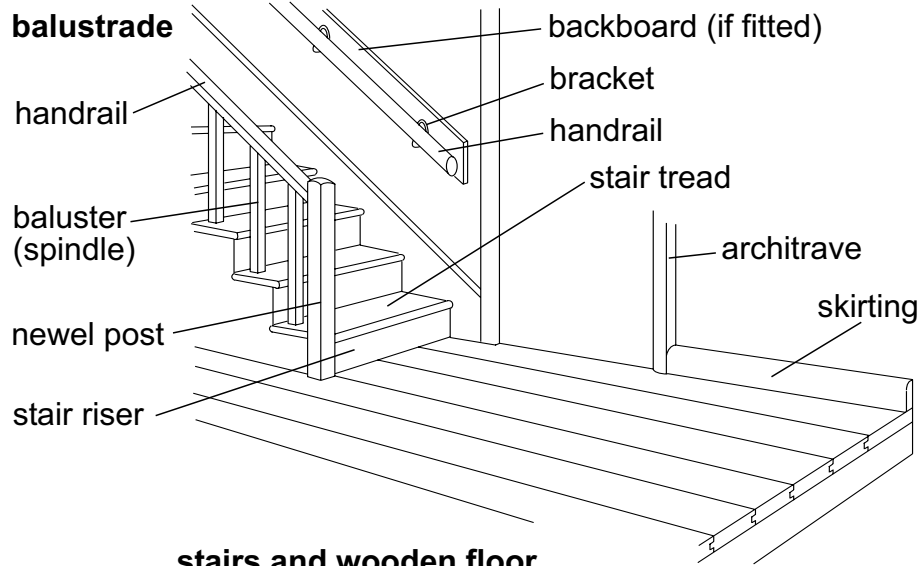

**stairs and wooden floor**

## Your responsibilities

## Advice

- Repairing any floor covering, vinyl tiles, sheeting, carpets or laminate, except for coverings we have provided in the bathroom or kitchen.

- The contractor will not accept responsibility for damage to your carpets or other floor coverings unless it is caused by neglect by their repair workers. If the contractor tells you that you need to lift your floor covering (including laminate flooring), you should do this before the repair workers arrive. Let us know if you are having difficulty arranging this.
- If we have to replace floor tiles, we may not be able to match the colour.
- If you, a member of your family or a visitor cause damage and we have to repair it, you will have to pay the cost of the repair.
- If a water leak or other problem damages floor coverings you have put in, we will not replace them. You should take out home contents insurance to help you pay for such items. Support staff or Scheme Co-ordinators may be able to help when this happens in supported or sheltered housing.

## We need to know

- **What is the problem, eg:** floorboard or skirting loose or damaged; tread or riser broken; handrail loose or broken; floor covering lifting or damaged?
- **What is the floor made of:** floorboards, chipboard or concrete?
- **What type of floor covering is it, eg:** quarry tiles (red), plastic tiles or sheeting, or non-slip flooring for disability?
- **How many boards, panels or tiles are affected?**
- **If stair nosing, is it on communal stairs? If so, is it metal or plastic?**



## Floors, stairs

About this book	1
How to contact us	3
Reporting repairs	5
Our service	7
What you must do	9
Response times	11
Our standards	13
Improvements	15

Baths, basins	17
Communal areas	19
Doors, locks	21
Drains, wastes	23
Electrics	25
Floors, stairs	27

<b>Garden area</b>	
Gutters	31
Heating	33
Kitchen fittings	35
Pipes, taps	37
Roofs	39
Toilets	41
Walls, ceilings	43
Windows	45

Handy hints 47 - 60

# Garden area

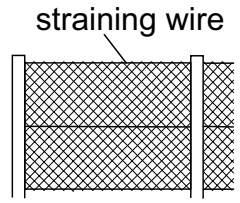

**chain link**

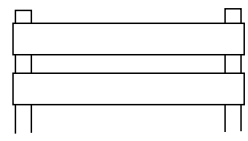

**post and rails (ranch)**

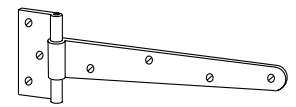

**'T' hinge**

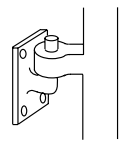

**hook hinges**

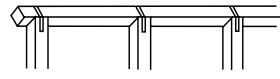

**trip rail**

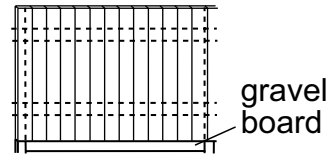

**close boarding**

**hinges**

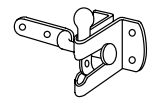

**gate catch**

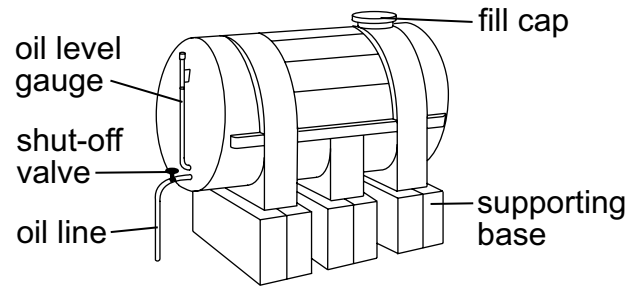

**oil tank**

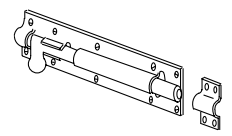

**barrel bolt**

## Your responsibilities

- Repairing sheds and outbuildings.
- Maintaining general garden paths (not those leading from the road to your front or back doors) and other general garden features, such as patios, ponds or ornamental walls.
- Replacing washing lines, unless they are in a communal area.

## Advice

- If a problem is caused by civil unrest, you should report it to the police and get a crime report number (not an incident number), otherwise we will charge you for the repair.
- Do not grow shrubs or climbing plants near or against the walls of the building. These can damage the bricks and cause damp problems.
- If you, a member of your family or a visitor cause damage and we have to repair it, you will have to pay the cost of the repair.

## We need to know

- **What is the problem, eg:** fence loose or broken; gate sticking; gate catch missing; path uneven or cracked; oil tank leaking?
- **If a fence, what type is it, eg:** wooden boarding, chain link, wire strand? How much is affected (length)? How high is it (approximately)?
- **If a gate or post, what type is it, eg:** wooden, metal or concrete (posts only)?
- **If a path, what is it made of, eg:** slabs, concrete, tarmac, blocks?



## Garden area

# Gutters

About this book	1
How to contact us	3
Reporting repairs	5
Our service	7
What you must do	9
Response times	11
Our standards	13
Improvements	15

Baths, basins	17
Communal areas	19
Doors, locks	21
Drains, wastes	23
Electrics	25
Floors, stairs	27
Garden area	29

<b>Gutters</b>	
Heating	33
Kitchen fittings	35
Pipes, taps	37
Roofs	39
Toilets	41
Walls, ceilings	43
Windows	45

Handy hints	47 - 60
-------------	---------

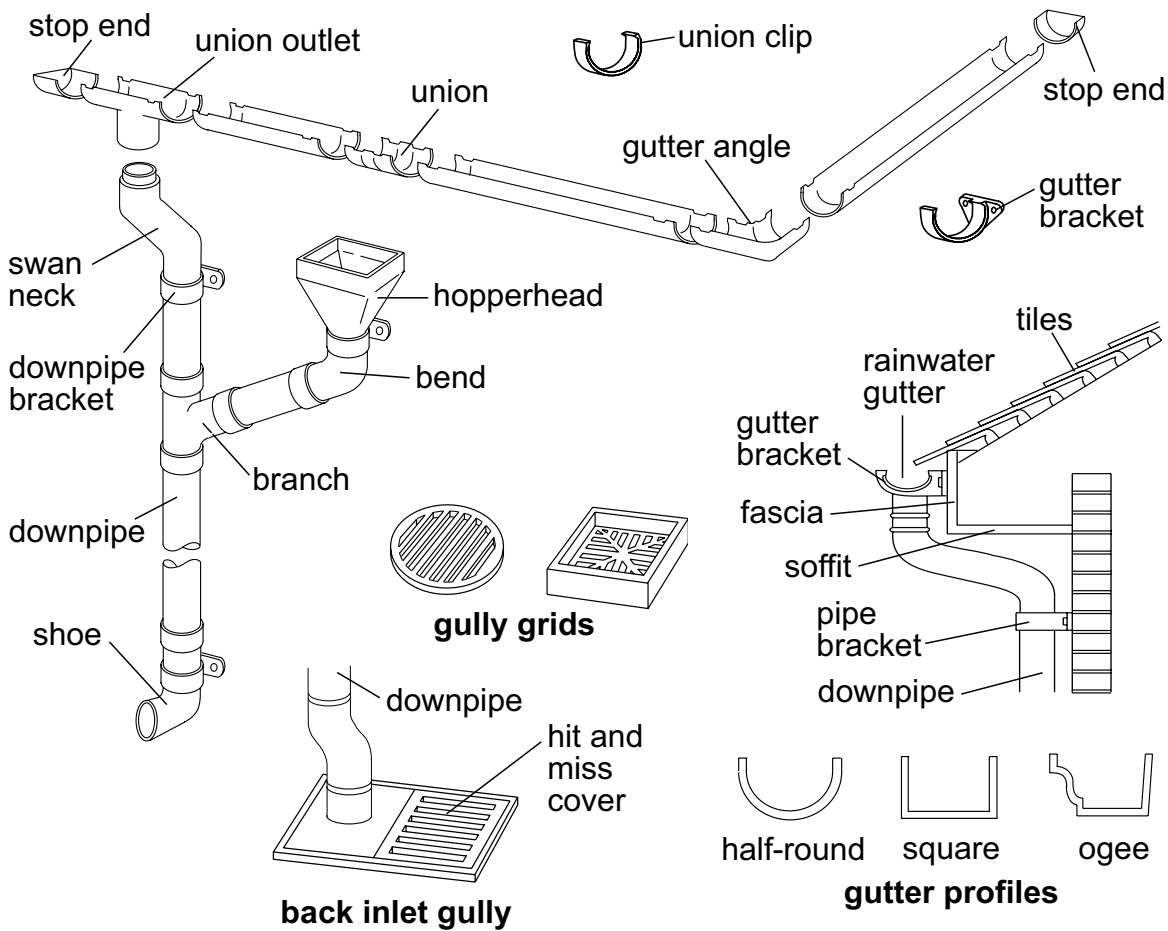



## Your responsibilities

- Keeping gully grids clear of leaves and rubbish.
- Clearing gutters if necessary to prevent blockages. See **Advice** below.

## Advice

- We may need to put up scaffolding for certain types of gutter repair.
- In bad weather conditions repair workers cannot work at height, eg on ladders, scaffolding or on the roof. This is for their own safety.
- If you, a member of your family or a visitor cause damage and we have to repair it, you will have to pay the cost of the repair.

## We need to know

- **What is the problem, eg:** gutter or downpipe loose, leaking or blocked; bracket, joint or shoe loose or broken?
- **Which gutter or downpipe is it:** front, back or side?
- **What shape is it:** half-round, square or ogee? **What colour is it?**
- **What is the gutter or downpipe made of:** metal or plastic?
- **If a gully grid:** is it round or square? **What is it made of:** metal or plastic?
- **How many storeys high is the building?**
- **Are there any other connected problems?**



About this book	1
How to contact us	3
Reporting repairs	5
Our service	7
What you must do	9
Response times	11
Our standards	13
Improvements	15

Baths, basins	17
Communal areas	19
Doors, locks	21
Drains, wastes	23
Electrics	25
Floors, stairs	27
Garden area	29
Gutters	31

<b>Heating</b>	
Kitchen fittings	35
Pipes, taps	37
Roofs	39
Toilets	41
Walls, ceilings	43
Windows	45

Handy hints 47 - 60

# Heating

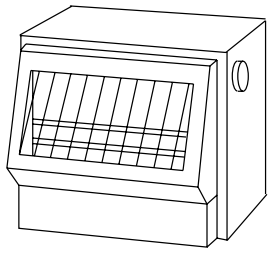

**solid fuel heater**

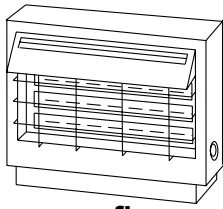

**gas fire**

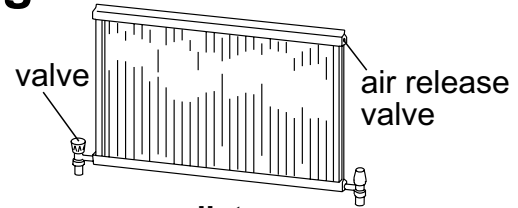

**radiator**

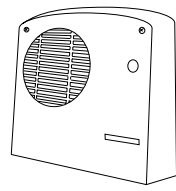

**bathroom convector heater**

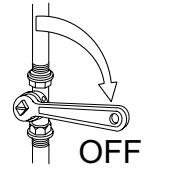

**mains gas tap**

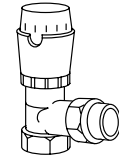

**thermostatic valve**

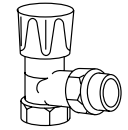

**standard valve**

**radiator valves**

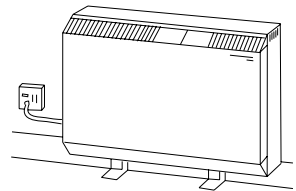

**electric Economy 7 heater**

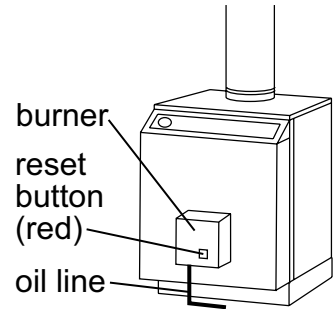

**floor-mounted oil central heating boiler**

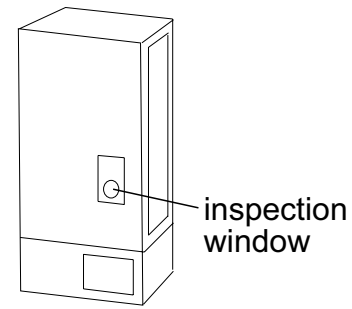

**wall-mounted central heating boiler**

## Your responsibilities

- If you smell gas, see **Emergencies - what to do** on page 2. Do not use a phone inside your home, not even a mobile; it could spark an explosion.
- Checking that your heating controls (room thermostat, timer or programmer) are set correctly. See **Handy hints** on page 55.
- Getting your own appliances repaired and serviced by qualified engineers.
- Keeping your home properly heated and ventilated to prevent condensation and to prevent pipes from bursting during cold weather.

## Advice

- We respond to heating breakdowns on the day you call. If the heating is not working by the end of the day (in cold weather), we can provide you with a temporary heater if you do not have one of your own.
- If your heating is not working, please check that your gas supply has not been disconnected because you have failed to pay your gas bill or run out of credit on the meter, or, if you have oil, that you have not run out of oil.
- If a radiator is leaking or loose because you have been doing redecoration work, we may charge you for the cost of the repair.

## We need to know

- **What is the problem, eg:** all or part of the central heating not working; no hot water; radiator leaking or not getting warm; fire or heater not working?
- **What type of system is it:** gas, oil or electric? Is it a wall-mounted boiler, separate gas fire, or an Economy 7 or convector heater?
- **Do you have another form of heating or hot water heating?**
- **If a radiator:** is it warm at the bottom and cold at the top?



## Heating

About this book	1
How to contact us	3
Reporting repairs	5
Our service	7
What you must do	9
Response times	11
Our standards	13
Improvements	15

Baths, basins	17
Communal areas	19
Doors, locks	21
Drains, wastes	23
Electrics	25
Floors, stairs	27
Garden area	29
Gutters	31
Heating	33

### Kitchen fittings

Pipes, taps	37
Roofs	39
Toilets	41
Walls, ceilings	43
Windows	45

Handy hints 47 - 60

# Kitchen fittings

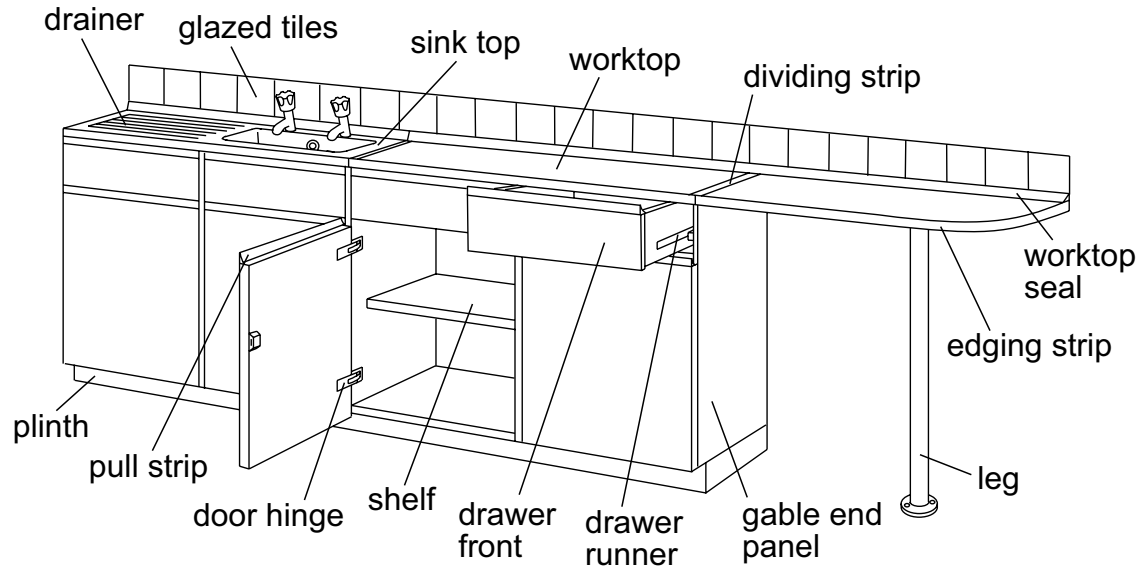
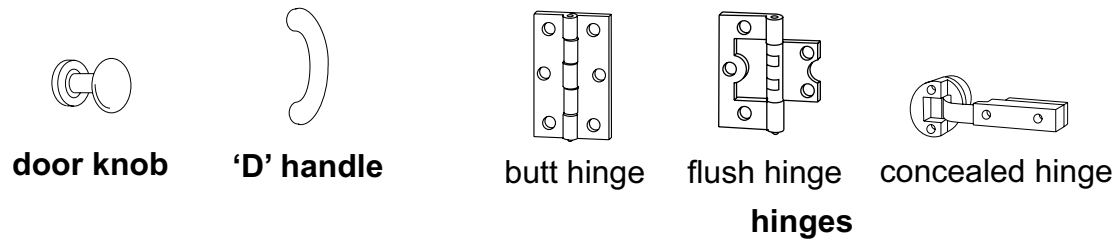

## Your responsibilities

- Installing a washing machine, dishwasher or tumble drier, including the waste, supply pipe and vent connections. See **Advice** below.
- Clearing any blockages in your washing machine or dishwasher.
- Repairing any extra kitchen units you have installed.

## Advice

- If you, a member of your family or a visitor cause damage and we have to repair it, you will have to pay the cost of the repair.
- If we have to replace kitchen units or parts of a unit, such as the worktop, drawer or door, we will try to match the colour and style, but this is often not possible.
- If you install a washing machine, dishwasher or tumble drier, you are responsible for providing the water supply, waste or vent connections if there are none already fitted. You must get our permission to do this work. Once they are installed, we will carry out repairs to these connections, but you are responsible for repairs to the appliances and for any blockages.

## We need to know

- **What is the problem, eg:** wall or floor unit loose or damaged; worktop loose or broken; cupboard door or drawer damaged; cupboard hinge or catch broken?
- **What type of unit is it:** wall or floor? Is it a tall unit or a corner unit? Is it a single or a double unit?
- **If wall tiles, what shape, size and colour are they?**
- **Are there any other connected problems?**



## Kitchen fittings

# Pipes and taps

About this book	1
How to contact us	3
Reporting repairs	5
Our service	7
What you must do	9
Response times	11
Our standards	13
Improvements	15

Baths, basins	17
Communal areas	19
Doors, locks	21
Drains, wastes	23
Electrics	25
Floors, stairs	27
Garden area	29
Gutters	31
Heating	33
Kitchen fittings	35

<b>Pipes, taps</b>	
Roofs	39
Toilets	41
Walls, ceilings	43
Windows	45

Handy hints	47 - 60
-------------	---------

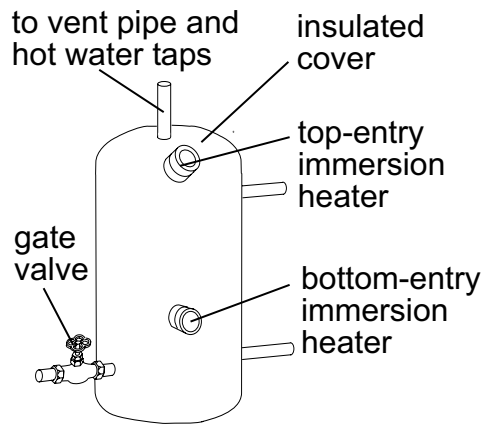

**hot water cylinder**

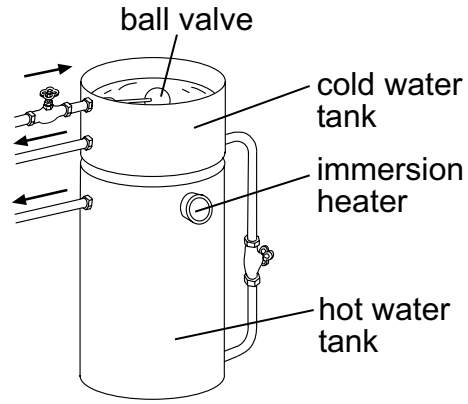

**combination tank**

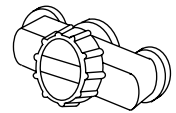

**shower mixing valve**

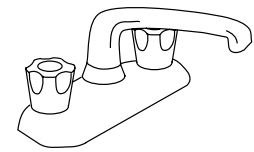

**mixer tap**

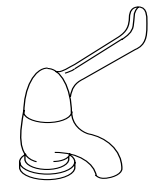

**lever tap valve**

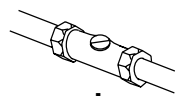

**service valve**



handwheel  
**modern**



crosshead  
**standard**

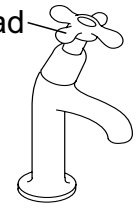

**high neck**

**pillar taps**

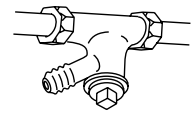

**draintap (drain valve)**

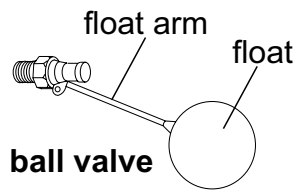

**ball valve**

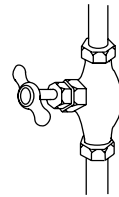

**stoptap (mains water)**

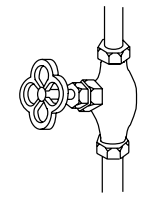

**gate valve (controls part of the system)**

## Your responsibilities

- Taking steps to prevent pipes from freezing or bursting during cold weather, particularly if you are away from home. See **Advice** below.
- Turning off your water supply at the stoptap if a water pipe has burst, and then turning on all taps to allow remaining water to flow out.
- Fitting supply pipework for washing machines and dishwashers (if not already provided).

## Advice

- You should know where the stoptap is in order to turn the water off in an emergency. It is normally under the kitchen sink or in the downstairs toilet. Make a note of where it is on page 2.
- If water is leaking onto electrical fittings, do not touch them and isolate the circuit at the consumer unit. See **Handy hints** on page 49.
- If damage is caused by water leaking, you may be able to make an insurance claim on your own contents insurance. See **Home contents insurance** on page 4.
- If you are away from home during cold weather, we advise you to leave your heating on, on a low setting. This will prevent water freezing in pipes.

## We need to know

- **What is the problem, eg:** no water, pipe leaking or burst; overflow running or broken; tap dripping or faulty?
- **If water is leaking into your property:** is it coming from the flat above? What is the address? **Are there any other connected problems?**
- **If no water:** do your neighbours have water or not?

## Pipes, taps

About this book	1
How to contact us	3
Reporting repairs	5
Our service	7
What you must do	9
Response times	11
Our standards	13
Improvements	15

Baths, basins	17
Communal areas	19
Doors, locks	21
Drains, wastes	23
Electrics	25
Floors, stairs	27
Garden area	29
Gutters	31
Heating	33
Kitchen fittings	35
Pipes, taps	37

<b>Roofs</b>	
Toilets	41
Walls, ceilings	43
Windows	45

Handy hints 47 - 60

# Roofs

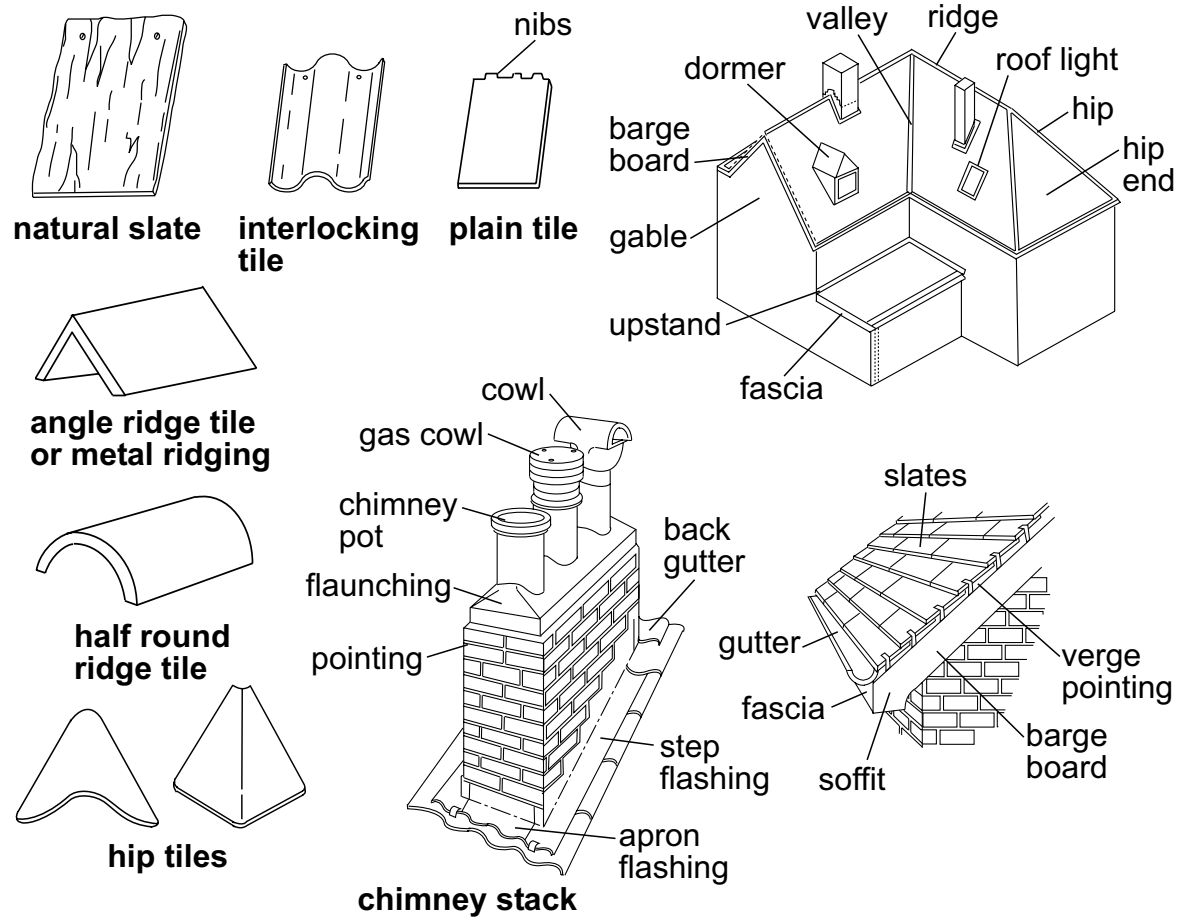



## Your responsibilities

## Advice

- Looking after any aerial or satellite dish fixed to your home. See **Advice** below.

- We may need to put up scaffolding for certain types of roof repair.
- In bad weather conditions repair workers cannot work at height: on ladders, scaffolding or on the roof.
- Do not use electrical fittings if they are wet because the roof is leaking. Do not use any switches connected to them. Contact us immediately.
- If you want to put up a satellite dish on your house or on a communal building (high-rise or block of flats) you must write to us and get our permission before you put it up.
- We will tell you if we need to take down an aerial or satellite dish to carry out repair work.

## We need to know

- **What is the problem, eg:** roof leaking; tiles or slates loose or broken; chimney pot or cowl fallen or loose; chimney stack crumbling?
- **What type of roof covering is it, eg:** slate, tiles, corrugated sheeting, flat felting or asphalt?
- **If tiles, what type are they, eg:** flat, ridge, interlocking or hip?
- **How many storeys high is the property?**
- **Is the roof leaking?**
- **Is the chimney shared with another property? What is the address?**



## Roofs

About this book	1
How to contact us	3
Reporting repairs	5
Our service	7
What you must do	9
Response times	11
Our standards	13
Improvements	15

Baths, basins	17
Communal areas	19
Doors, locks	21
Drains, wastes	23
Electrics	25
Floors, stairs	27
Garden area	29
Gutters	31
Heating	33
Kitchen fittings	35
Pipes, taps	37
Roofs	39

<b>Toilets</b>	
Walls, ceilings	43
Windows	45

Handy hints 47 - 60

# Toilets

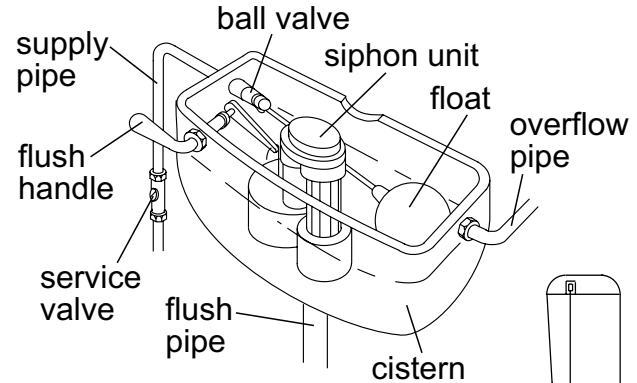
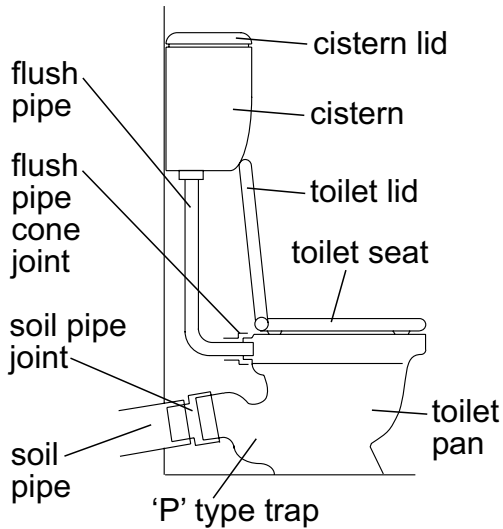

**toilet cistern**



close-coupled

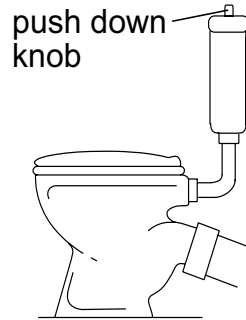

flush panel



standard

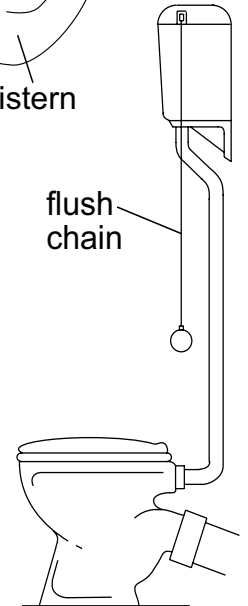

**high-level cistern**

**low-level cisterns**

## Your responsibilities

- Repairing or replacing toilet seats.
- Fitting toilet roll holders.
- Trying to clear blocked toilets. See **Handy hints** on page 47.

## Advice

- A blocked toilet is **not** an emergency unless you have no other toilet you can use.
- If a blockage is caused by items such as air fresheners, nappies or sanitary products, we will charge you for the cost of clearing it.
- We recommend you clean and clear your toilet regularly using cleaning products you can buy at shops. Always follow instructions carefully.
- If you, a member of your family or a visitor cause damage and we have to repair it, you will have to pay the cost of the repair.

## We need to know

- **What is the problem, eg:** toilet blocked; overflow running; cistern leaking; seat broken; pan cracked or leaking; flush handle or chain broken?
- **What type of cistern is it:** high-level or low-level? If low-level, is it a flush panel, close-coupled or standard type?
- **What type of handle is it:** lever handle, push down knob or chain?
- **What colour is the suite?**
- **If toilet is blocked in a block of flats,** are any other flats affected?



## Toilets

About this book	1
How to contact us	3
Reporting repairs	5
Our service	7
What you must do	9
Response times	11
Our standards	13
Improvements	15

Baths, basins	17
Communal areas	19
Doors, locks	21
Drains, wastes	23
Electrics	25
Floors, stairs	27
Garden area	29
Gutters	31
Heating	33
Kitchen fittings	35
Pipes, taps	37
Roofs	39
Toilets	41

## Walls, ceilings

Windows	45
---------	----

Handy hints	47 - 60
-------------	---------

# Walls and ceilings

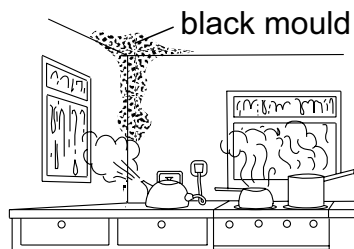

**condensation**

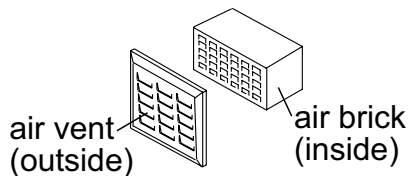

**ventilation**

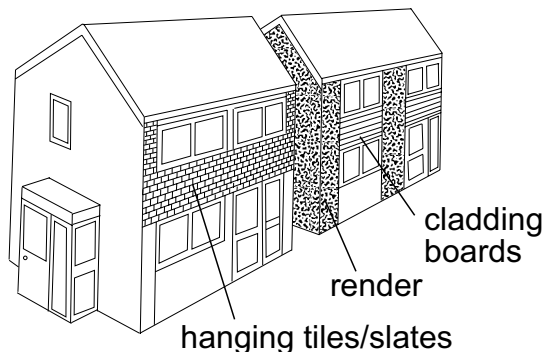

a possible cause of dampness is earth mounded over the damp proof course

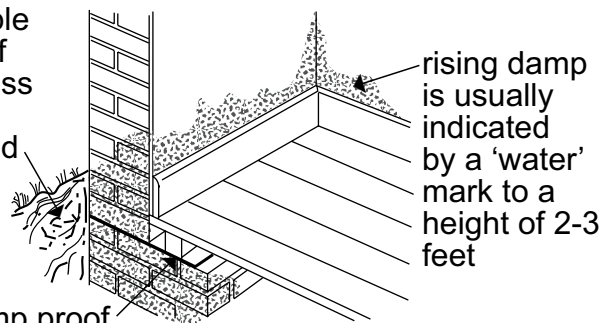

**damp proof course**

**damp/mould**

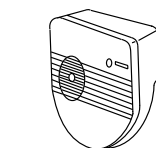

**extractor fan**

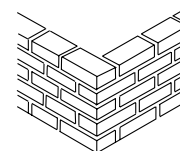

**half brick wall**

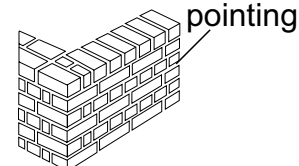

**full brick wall**

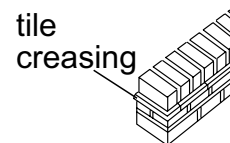

**brick on edge coping**

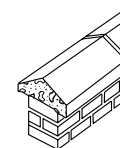

**precast concrete coping**

**boundary walls**

## Your responsibilities

- Decorating walls and ceilings inside your home to a reasonable standard.
- Filling minor cracks and holes in walls and ceilings.
- Preventing and controlling the build up of moisture to prevent damp and mould appearing on the walls or ceiling. See **Handy hints** on page 53.
- Keeping air vents clear and using extractor fans (where provided).
- Fitting and replacing curtain rails, pelmets, picture rails, and hooks.

## Advice

- If you, a member of your family or a visitor cause damage and we have to repair it, you will have to pay the cost of the repair.
- Do not grow shrubs or climbing plants near or against the walls of your building. These can damage the bricks and cause damp problems.
- If you want to put up a satellite dish on your house or a communal building (high-rise or block of flats) you must write to us and get our permission first.

## We need to know

- **What is the problem, eg:** wall plaster loose or crumbling; ceiling plaster bulging; condensation or mould on walls or ceiling; graffiti?
- **Is there any damage caused by water leaking?**
- **If outside, what type of wall surface is it:** render (pebbledash or smooth), pvcu boards, timberboards or hanging tiles or slates?
- **If wall tiles (inside),** what shape, size and colour are they?
- **If a wall, what is it made of:** brick or concrete blocks?
- **If graffiti,** where is it and what does it say?



## Walls, ceilings

# Windows

About this book	1
How to contact us	3
Reporting repairs	5
Our service	7
What you must do	9
Response times	11
Our standards	13
Improvements	15

Baths, basins	17
Communal areas	19
Doors, locks	21
Drains, wastes	23
Electrics	25
Floors, stairs	27
Garden area	29
Gutters	31
Heating	33
Kitchen fittings	35
Pipes, taps	37
Roofs	39
Toilets	41
Walls, ceilings	43

## Windows

Handy hints 47 - 60

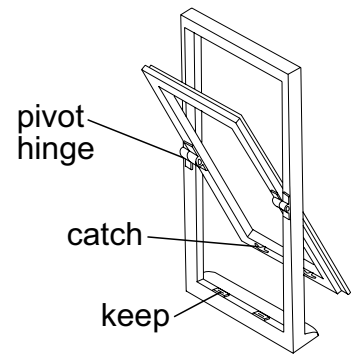
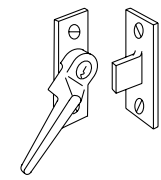
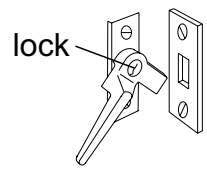
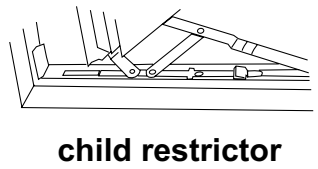
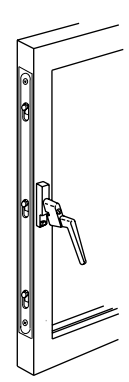
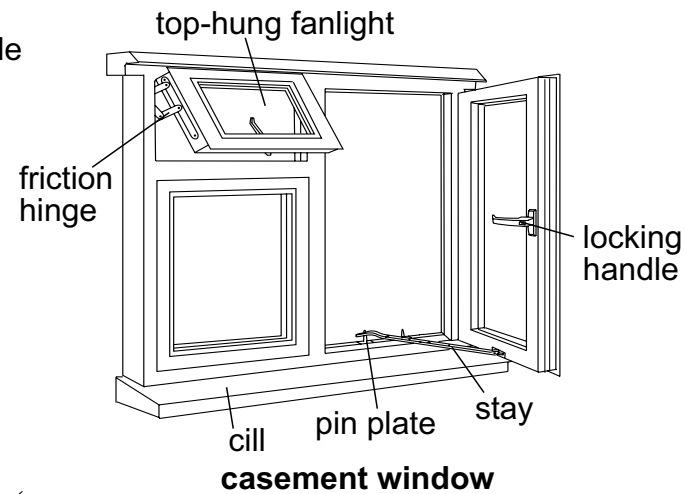
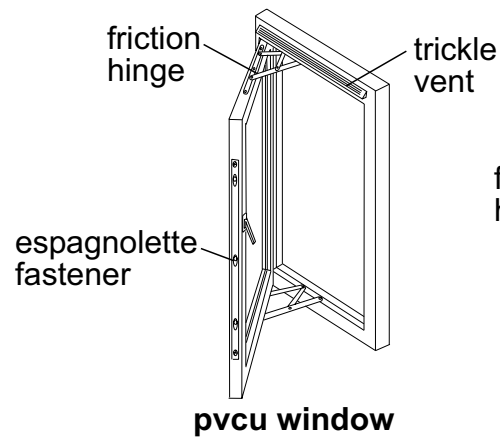

## Your responsibilities

- Replacing broken or cracked glass where no police crime report number can be provided. See **Advice** below.
- Cleaning window trickle vents.
- Keeping window trickle vents clear and using them.

## Advice

- If a problem is caused by civil unrest, you should report it to the Police and get a crime report number (not an incident number), otherwise we will charge you for the cost of the repair.
- If you, a member of your family or a visitor cause damage and we have to repair it, you will have to pay the cost of the repair.

## We need to know

- **What is the problem, eg:** glass cracked or broken; frame loose or jammed; stay or fastener broken?
- **What type of frame is it:** wooden, plastic (pvcu) or metal?
- **What style of window is it:** casement, pivot or pvcu type?
- **What type of glass is it, eg:** plain, obscure, or wired? Is it double glazed?
- **Are there any other connected problems?**
- **If a fastener, what type is it?**



About this book	1
How to contact us	3
Reporting repairs	5
Our service	7
What you must do	9
Response times	11
Our standards	13
Improvements	15

Baths, basins	17
Communal areas	19
Doors, locks	21
Drains, wastes	23
Electrics	25
Floors, stairs	27
Garden area	29
Gutters	31
Heating	33
Kitchen fittings	35
Pipes, taps	37
Roofs	39
Toilets	41
Walls, ceilings	43
Windows	45

## Handy hints

# Clearing a blocked waste

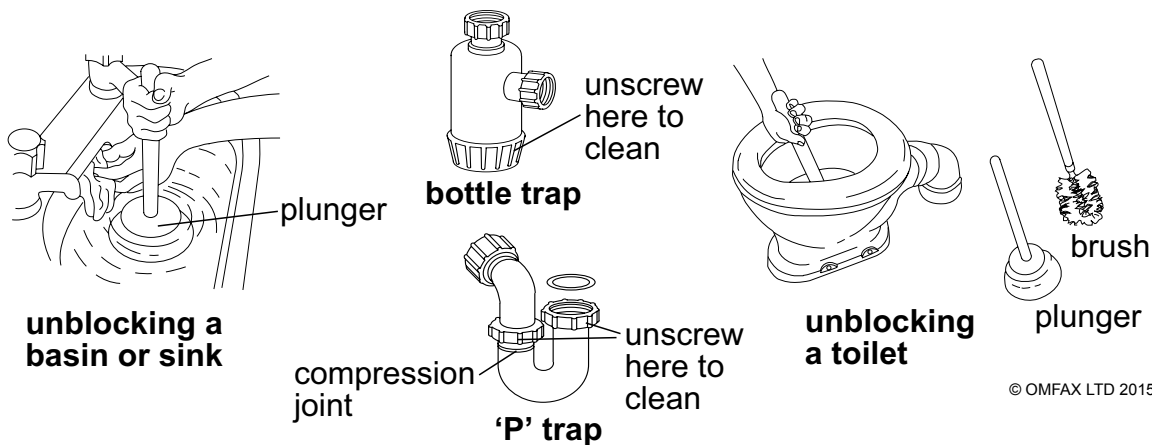

© OMFAX LTD 2015

## General advice

- Blockages in basins and sinks are usually caused by the build-up of waste in the trap: fat, tea leaves, hair etc. It is advisable to clear wastepipes and traps at least once a month with a cleaning product you can buy at shops. Always follow the instructions carefully. **Do not** use caustic soda as it destroys modern plastic fittings.
- The trap always holds some water which stops air or foul smells coming up the drain. However, waste can build up and become stuck in it.
- If more than one fitting (bath, basin or sink) is blocked, the blockage may be in the soil stack or main drain. This will need to be cleared by us. Contact us.
- Blockages in toilets are usually caused by unusual objects: nappies, toys or toilet fresheners. You must not use toilets as bins or waste disposers.



## What to do

### You need:

- bowl or bucket;
- jug or cup to be used as a scoop;
- wet rag or dishcloth;
- plunger - for the toilet you can use a toilet brush or mop; and
- protective gloves.

### To unblock a bath, basin or sink:

- scoop out most of the water;
- hold the rag tightly over the overflow opening; and
- place the plunger over the plug hole and pump up and down rapidly.

### To unblock a toilet:

- if the pan is already full, remove some of the water into a bucket using some form of scoop, eg a jug or cup;
- push the brush or plunger to the bottom of the pan;
- pump it up and down vigorously about 10 times. This creates a vacuum and pressure, which may shift the blockage; and
- flush the toilet to see whether the blockage has gone.

You may need to repeat this process several times before the toilet flushes normally. If there is no improvement after a couple of attempts, you should contact us.

Thoroughly wash your hands and all equipment after you have finished.

About this book	1
How to contact us	3
Reporting repairs	5
Our service	7
What you must do	9
Response times	11
Our standards	13
Improvements	15

Baths, basins	17
Communal areas	19
Doors, locks	21
Drains, wastes	23
Electrics	25
Floors, stairs	27
Garden area	29
Gutters	31
Heating	33
Kitchen fittings	35
Pipes, taps	37
Roofs	39
Toilets	41
Walls, ceilings	43
Windows	45

## Handy hints

# Resetting a trip switch

If your lights or power go off, it means your trip switches are working properly. You can find out what caused the problem and sort it out quite easily.

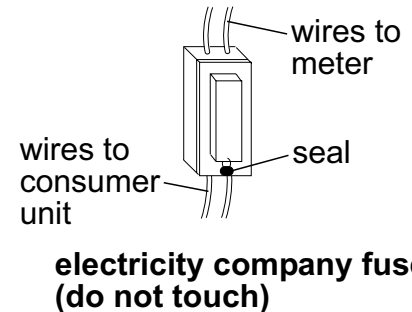
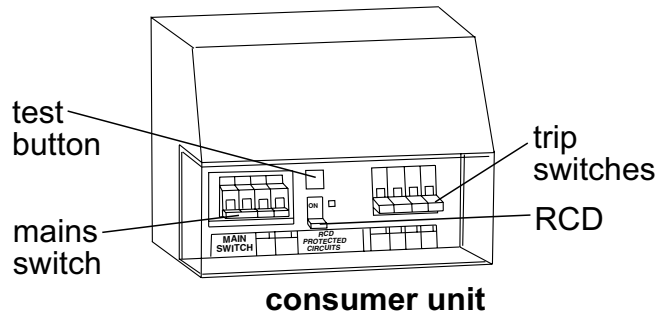

## General advice

- Modern electric circuits are fitted with circuit breakers called trip switches. If a fault develops, a switch is tripped and the circuit is broken.
- All of the fuses or trip switches are located in the consumer unit. Some consumer units have buttons rather than switches. The consumer unit may be next to the electricity meter (unless the meter is in an outside cupboard).
- A trip switch or button usually operates because:
  - there are too many appliances on a circuit and it is overloaded;
  - an appliance is faulty or has been misused, such as a kettle has been over-filled or a toaster not cleaned;
  - water has leaked into a circuit or spilt onto a plug;
  - a light bulb has blown; or
  - an immersion heater is faulty.

## General advice (continued)

- If one of your electrical appliances is faulty, leave it unplugged and get a qualified electrician or service engineer to check it.
- If a wall or ceiling light is faulty, keep it switched off (put some tape over the switch) and contact us.
- **Make sure your hands are dry when you touch electrical fittings.**
- **Never touch the electricity company's fuse and seals.**

This advice only applies to modern consumer units. If you have an older 'fuse board' type with rewirable cartridges, see the guidance on page 51.

### To reset a trip:

- open the cover on the consumer unit to expose the trip switches/buttons;
- check which switches/buttons have tripped to the OFF position and which rooms (circuit) have been affected; and
- put these switches/buttons back to the ON position.

**If the trip goes again**, it is probably being caused by a faulty appliance or light. You need to identify which circuit is being affected and which appliance on that circuit is causing the problem:

- check all the rooms and note which set of lights or sockets is not working;
- unplug all appliances on that problem circuit, and switch off the immersion heater;
- switch the 'tripped' switch to the ON position (press in if it is a button); and
- plug in the appliances or switch on each light one at a time until the trip goes again. Do not use adaptors when testing appliances.

# Changing a mains fuse

About this book	1
How to contact us	3
Reporting repairs	5
Our service	7
What you must do	9
Response times	11
Our standards	13
Improvements	15

Baths, basins	17
Communal areas	19
Doors, locks	21
Drains, wastes	23
Electrics	25
Floors, stairs	27
Garden area	29
Gutters	31
Heating	33
Kitchen fittings	35
Pipes, taps	37
Roofs	39
Toilets	41
Walls, ceilings	43
Windows	45

## Handy hints

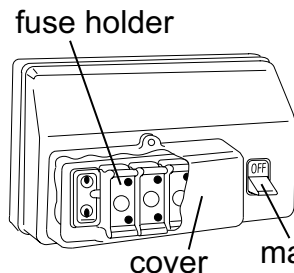

**consumer unit (fuse box)**

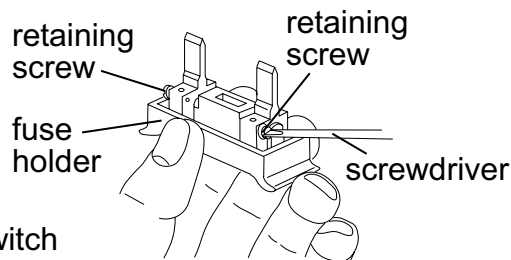

**rewirable fuse**

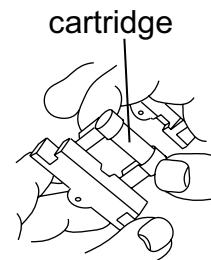

**cartridge fuse**

© OMFAX LTD 2015

## General advice

- The fuse box or consumer unit is normally located next to the electricity meter.
- Fuses usually blow because:
  - a circuit has been overloaded because too many appliances are being used at the same time;
  - an appliance is faulty; or
  - a light bulb has blown.
- Always replace a cartridge or fuse wire with one of the correct rating.
  - 5 amp for lights
  - 20 amp for the immersion heater
  - 30 amp for sockets and cookers (sometimes the cooker cartridge will be 45 amp)
- Mark the name of each circuit on the inside of the fuse cover.

## You need:

- torch;
- screwdriver with an insulated handle; and
- fuse wire or cartridge fuse of the correct rating.

## What to do

- Switch off the mains switch and unplug all appliances.
- Unscrew the cover and pull out each fuse holder to check which has blown.
- If it is a rewirable fuse, loosen the retaining screws at either end, remove any old wire and feed new wire of the correct rating through the holder and around the screws. Tighten up the screws at both ends.
- If it is a cartridge fuse, take out the old cartridge, fit a new one into the holding clips and replace the fuse holder.
- Switch the mains switch back on and check that all circuits are working.
- Plug in each appliance one at a time to check if the fuse blows again. If this happens, the appliance is faulty and you should get it repaired by a qualified electrician or service engineer.
- Screw the cover back in place.

# Condensation

About this book	1
How to contact us	3
Reporting repairs	5
Our service	7
What you must do	9
Response times	11
Our standards	13
Improvements	15

Baths, basins	17
Communal areas	19
Doors, locks	21
Drains, wastes	23
Electrics	25
Floors, stairs	27
Garden area	29
Gutters	31
Heating	33
Kitchen fittings	35
Pipes, taps	37
Roofs	39
Toilets	41
Walls, ceilings	43
Windows	45

## Handy hints

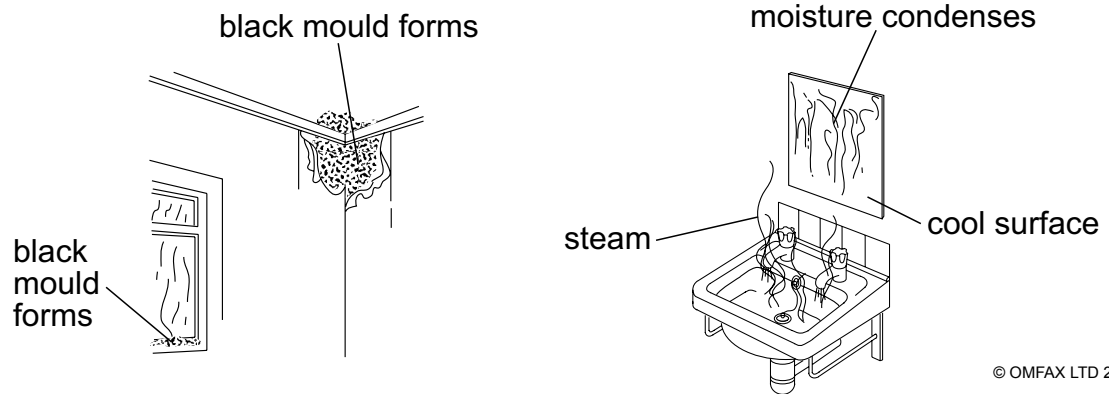

© OMFAX LTD 2015

## What is condensation?

- It starts as moisture that is produced by cooking, washing or drying clothes indoors on radiators, or having a lot of people in one room.
- This moist air condenses on cool surfaces such as walls, mirrors, wall tiles and windows, and even some clothes.
- When the moist air is warm it rises and often ends up on ceilings and in upstairs rooms and then forms mould.

## If mould forms:

- wipe the mould off immediately with water. Do **not** use washing up liquid; and
- apply a recommended product available from a hardware or DIY store. Always follow the instructions carefully.

## Preventing condensation

Condensation can occur in any home. You can take steps to prevent it.

### Control excess moisture:

- close kitchen and bathroom doors to prevent steam going into other colder rooms;
- open kitchen and bathroom windows when cooking or washing so that steam can escape, or use an extractor fan if you have one fitted;
- open some windows in other rooms for a while each day to allow a change of air;
- do not use bottled gas heaters - the gas produces a lot of moisture;
- wipe down surfaces where moisture settles to prevent mould forming;
- do not block air vents; and
- make sure you keep window trickle vents open.

### Produce less moisture:

- dry clothes outdoors whenever possible, otherwise use well ventilated rooms;
- cover pans when cooking; and
- vent any tumble driers to the outside.

### Keep your house warm:

- take steps to prevent heat loss; and
- maintain low background heat. This doesn't necessarily cost more.

About this book	1
How to contact us	3
Reporting repairs	5
Our service	7
What you must do	9
Response times	11
Our standards	13
Improvements	15

Baths, basins	17
Communal areas	19
Doors, locks	21
Drains, wastes	23
Electrics	25
Floors, stairs	27
Garden area	29
Gutters	31
Heating	33
Kitchen fittings	35
Pipes, taps	37
Roofs	39
Toilets	41
Walls, ceilings	43
Windows	45

## Handy hints

# Adjusting heating controls

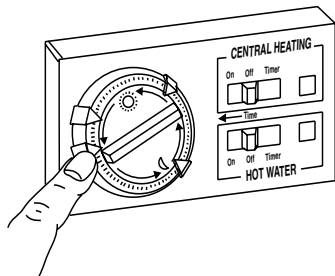

**timeclock programmer**

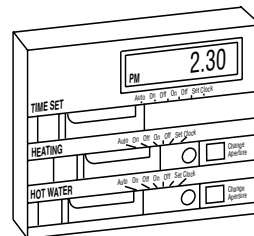

**digital programmer**

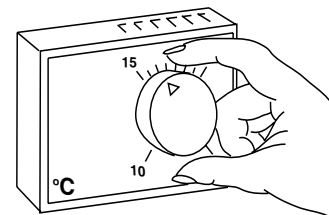

**room thermostat**

© OMFAX LTD 2015

## General advice

- A timeclock or digital programmer automatically turns the heating and hot water on and off at the times you set. You can set them to come on once, twice or stay on all the time, as you require. You have three switches:
  - AUTO, which turns the heating and hot water on or off at the times you set;
  - ON, which you can use to manually override the set starting time; and
  - OFF, which you can use to manually override the set finishing time.
- Set the heating to go off during the night and when the home is empty during the day.
- During freezing spells, keep some background heat on all the time.
- A room thermostat controls the heating to keep the room at a set temperature. Turn the dial so that the arrow or marker points to the temperature you want. A comfortable and economic temperature is between 18°C and 20°C.



## Timeclock programmer

- Check the clock is showing the correct time and adjust if necessary.
- Decide when you want the heating and hot water to come on and go off.
- Timeclock programmers will have sets of pins or arrows for setting the heating programme.

### Pins:

- push them in opposite the times when you want the heating to come on; and
- pull them out opposite the times when you want the heating to go off.

### Arrows:

- slide the 'on' arrows (usually red) around to the times you want the heating to come on;
- slide the 'off' arrows (usually blue) around to the times you want the heating to go off; and
- check that the programmer is switched to 'timer' (or 'auto') to activate the times you have set.

## Digital programmer

- Check the clock is showing the correct time. If not, put the timer switch to 'clock' and adjust the time using the 'forward' and 'reverse' buttons.
- Set the switch to 'on' and 'off' in turn adjusting the times when you want the heating to come on and go off.
- Reset the timer switch to 'auto' and double check that the settings on display are as you have set.

# About your smoke detector

About this book	1
How to contact us	3
Reporting repairs	5
Our service	7
What you must do	9
Response times	11
Our standards	13
Improvements	15

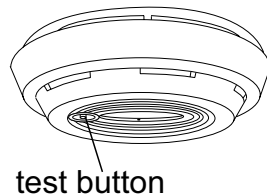
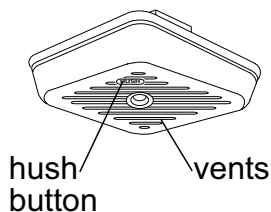

hush button

test button

smoke detectors

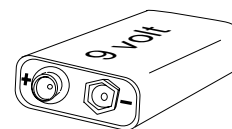

**9 volt battery  
(for battery-operated  
detectors only)**

© OMFAX LTD 2015

Baths, basins	17
Communal areas	19
Doors, locks	21
Drains, wastes	23
Electrics	25
Floors, stairs	27
Garden area	29
Gutters	31
Heating	33
Kitchen fittings	35
Pipes, taps	37
Roofs	39
Toilets	41
Walls, ceilings	43
Windows	45

## Handy hints

### If the alarm goes off

- Take your family to where it is easy to escape in case there is a fire.
- Check all rooms for signs of smoke.
- Feel around each door before opening it. If there is any sign of heat, smoke or noise, **don't open the door**.
- **But** if you live in a sheltered or supported scheme, you should follow the evacuation procedure for that site.

### If a fire has broken out:

- **do not attempt to tackle it yourself**. Smoke and fumes can kill in minutes;
- **get everyone out** of the house and **call** the Fire Service (999); and
- **don't go back** for any reason.

### If there is no sign of smoke or fire:

- The battery may need replacing. See **To replace a battery** on page 58. (You only need to do this if your smoke detector is battery-operated.)
- Or, something may have caused it to operate in error. See page 58.

### **A smoke detector may operate in error if:**

- a heater or clothes drier is too near it;
- someone smokes a cigarette or pipe near it or an aerosol spray is used near it;
- there are excessive cooking fumes or steam, eg: roasting meat or burnt toast;
- there are strong draughts from nearby doors or windows; or
- dust has built up in the detector (use a vacuum cleaner nozzle to clean).

### **To reset the alarm:**

- if it has a HUSH button, press the button. The alarm will stop for 10 seconds, but it then beeps every 40 seconds. If the problem does not clear after 10 minutes the alarm will continue; or
- if there is no HUSH button, turn off the electricity supply at the consumer unit for at least 15 minutes. Then switch the electricity back on.

### **To test your alarm:**

- press and hold the test button for a few seconds. The alarm should sound;
- if it doesn't sound, clean it with a vacuum cleaner nozzle and test again; and
- if the alarm still does not sound when tested after cleaning, replace the battery. If it still doesn't work you will need to replace the whole detector.

### **To replace a battery (only if it is battery-operated):**

- open the detector by gently prising off the cover;
- unclip the old battery from its connections and retaining clips;
- clip the new battery firmly into place. Check that the + and - signs on the battery match up with + and - signs on the detector; and
- close the detector and test it using the test button.

# Energy advice

If you save energy, you will save money too.

About this book	1
How to contact us	3
Reporting repairs	5
Our service	7
What you must do	9
Response times	11
Our standards	13
Improvements	15

Baths, basins	17
Communal areas	19
Doors, locks	21
Drains, wastes	23
Electrics	25
Floors, stairs	27
Garden area	29
Gutters	31
Heating	33
Kitchen fittings	35
Pipes, taps	37
Roofs	39
Toilets	41
Walls, ceilings	43
Windows	45

## Handy hints

### Use heating effectively

**Turn off heating when it is not needed**, at night or if the home is empty. In very cold weather, keep on a constant low heat to prevent frozen pipes.

### Use economical settings.

- Set heating to come on just before you get up or get home from work.
- Set it to go off before you go to bed.
- A comfortable and economic setting is 18°C to 22°C but turning down the room thermostat by 1°C is equal to turning it off for two hours.

### Keep to reasonable temperatures.

- Turn down radiator thermostats.
- Keep heat low but constant.
- Control hot-water temperatures.
- Turning up the room thermostat will not heat up a room faster.

### In spring, keep adjusting settings to come on for shorter periods.

- Turn down the thermostat.
- Turn down radiators that don't need to be on.
- Turn the heating off completely on warm days.

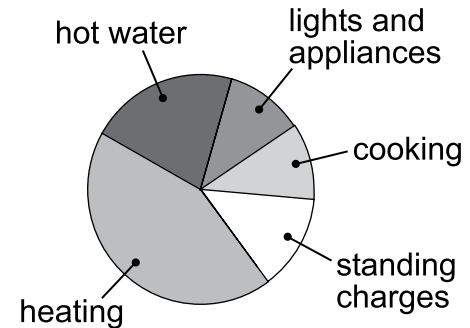

**Heating and hot water account for two-thirds of your fuel bills.**

## Preventing heat loss

### Draw curtains when it gets dark

- Use thick curtains with linings.
- Tuck curtains behind radiators.
- Tuck the bottom of curtains onto the cill to prevent draughts.

### Cut out draughts

- Draught proofing can cut heating bills by up to 10%.
- Fit a flap over the letterbox.
- Fit draught strips around outside door frames.
- Before opening outside doors, close all doors leading into the hall.

### Lagging

- Use a good underlay with carpets.
- Contact us if your hot-water cylinder is not already insulated, or you need lagging around hot-water pipes in the loft.

For more advice on how to save energy, contact us.

## Controlling costs

### Make adjustments to your routine

- How often do you need hot water?
- Do you need all the radiators on?
- Do you need the water so hot?
- Could you reduce room temperatures?

### Use appliances wisely

- Bar fires and fan heaters use up a lot of electricity.
- Set thermostats and timers for the best use of energy.

### Check how much fuel you use

Check your meter reading against your bill regularly, especially when it is estimated.

### Get the best deal

- Does your supplier have an economy tariff, or can you get a better deal from another supplier?
- Prepayment meters are expensive because of high standing charges.





**Choice**

Leslie Morrell House  
37-41 May Street  
Belfast BT1 4DN  
T: 0300 111 2211  
E: enquiries@choice-housing.org

**Choice**

Maple House  
Beechill Business Park  
96 Beechill Road  
Belfast BT8 7QN  
T: 0300 111 2211  
E: enquiries@choice-housing.org

[choice-housing.org](http://choice-housing.org)



Working  
together for  
positive change

No part of this document may be reproduced or transmitted in any form or by any means, electronic or mechanical, including photocopying, recording, or by any information storage or retrieval system without permission in writing from Omfax Ltd.

Designed and developed for Choice Housing Ireland by:  
Omfax Systems Limited, 21 The Causeway, Bicester,  
Oxon OX26 6AN  
[www.omfax.co.uk](http://www.omfax.co.uk) © OMFAX LTD 2015

